

FUERBA DENTRO

PRICELIST 2014



NOK Pricelist VAT incl.

ICONS



TOTAL VOLUME

THE TOTAL VOLUME OF THE FURNITURE INDICATES THE VOLUME OF ALL PACKED PARTS OF A COMPLETE PRODUCT FOR MORE DETAILED INFORMATION CHECK THE PRODUCT PACKAGING DATA SHEET



TOTAL WEIGHT

THE TOTAL WEIGHT OF THE FURNITURE INDICATES THE WEIGHT OF ALL PACKED PARTS OF A COMPLETE PRODUCT FOR MORE DETAILED INFORMATION CHECK THE PRODUCT PACKAGING DATA SHEET

ALL DIMENSIONS ARE IN CM - ALL WEIGHTS ARE IN KGS - ALL VOLUMES ARE IN M³

SPECIAL FEATURES:



ITEM WITH ADJUSTABLE FEET

THIS ICON IS USED FOR FURNITURE EQUIPED WITH ADJUSTABLE FEET, SO A STABILIZED AND LEVELED INSTALLATION OF THE ITEM IS POSSIBLE ON ALMOST ANY SURFACE



ITEM WITH WHEELS

THIS ICON IS USED FOR FURNITURE EQUIPED WITH 2 OR MORE WHEELS FOR EASY MOVING

FUERADENTRO
DENTRO

FUERADENTRO
PRINSENGRACHT 624S
1017 KT AMSTERDAM
THE NETHERLANDS

WWW.FUERADENTRO.COM
INFO@FUERADENTRO.COM

T +31 20 624 51 11
F +31 20 427 26 46

FURNITURE COLLECTIONS

CIMA COLLECTION	2
CUSHIONS CIMA COLLECTION	14
LOUNGE COLLECTION	15
MODULAR LOUNGE SYSTEM PARTS	20
CUSHIONS LOUNGE COLLECTION	23
SHELL COLLECTION	28
CUSHIONS SHELL COLLECTION & SCATTER CUSHIONS	32
E-VOLVED COLLECTION	33
ACCESSORIES & DECORATIONS	34
MATERIALS & FABRICS	36

FUERADENTRO RESERVES THE RIGHT TO ADJUST OUR PRICES AND MODELS AT ANY TIME. COLOURS ARE NOT BINDING.

COPYRIGHT

ALL FUERADENTRO DESIGNS, NAMES, PHOTOS AND INTELLECTUAL PROPERTY USED IN THIS BROCHURE ARE THE COPYRIGHT OF FUERADENTRO. ANY INFRINGEMENT OR ABUSE OF OUR COPYRIGHT WILL BE PURSUED BY LAW. FUERADENTRO ALWAYS RESERVES THE RIGHT TO MAKE CHANGES OR ADDITIONS TO THE DESCRIPTIONS OR FEATURES GIVEN IN THIS BROCHURE IN THE LIGHT OF TECHNICAL DEVELOPMENTS OR AVAILABILITY OF MATERIALS. WE ARE NOT RESPONSIBLE FOR VARIATIONS IN COLOUR, WEIGHT OR DIMENSIONS, AS VARIATIONS ARE POSSIBLE WHENEVER PRODUCTS ARE HAND-MADE.

ALL FUERADENTRO DESIGNS ARE REGISTERED TRADEMARKS AND COPYRIGHTED BY FUERADENTRO. OUR TRADEMARK IS PROTECTED BY LAW AND ALL INFRINGEMENTS AGAINST OUR TRADEMARK AND OUR COPYRIGHT WILL BE PURSUED BY LAW.

CIMA COLLECTION

FUERADENTRO

PRODUCT

PRICES & REFERENCES

SPECS

SILLÓN CHAIR

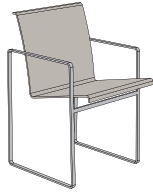

FRAME:		BRUSHED STAINLESS STEEL	ELECTRO POLISHED STAINLESS STEEL	POWDERCOATED STAINLESS STEEL WHITE	POWDERCOATED STAINLESS STEEL CENDRE	POWDERCOATED STAINLESS STEEL BLACK	TEAK
SEAT:							
BATYLINE®	WHITE	NOK 5.290 SLNWU	NOK 5.890 SLNEPWU	-	-	-	-
	CENDRE	NOK 5.290 SLNCE	NOK 5.890 SLNEPCE	-	-	-	-
	BLACK	NOK 5.290 SLNZU	NOK 5.890 SLNEPZU	-	-	-	-

SILLÓN
 M 0,31 m³ 13,4 kgs

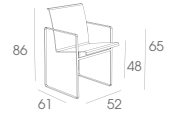

BUTAQUE CHAIR



FRAME:		BRUSHED STAINLESS STEEL	ELECTRO POLISHED STAINLESS STEEL	POWDERCOATED STAINLESS STEEL WHITE	POWDERCOATED STAINLESS STEEL CENDRE	POWDERCOATED STAINLESS STEEL BLACK	TEAK
SEAT:							
BATYLINE®	WHITE	NOK 5.290 BTQWU	NOK 5.890 BTQEPWU	NOK 5.890 BTQWULWU	-	-	NOK 5.890 BTQTWU
	CENDRE	NOK 5.290 BTQCE	NOK 5.890 BTQEPCE	-	NOK 5.890 BTQCAUCE	-	NOK 5.890 BTQTCE
	BLACK	NOK 5.290 BTQZU	NOK 5.890 BTQEPZU	-	-	NOK 5.890 BTQZULZU	NOK 5.890 BTQTZU
SEAT + BACK CUSHION		STANDARD TEMPLATES FABRIC NOK 1.590 FOR MORE INFORMATION ABOUT CUSHIONS SEE PAGE 14		SYNTHETIC LEATHER STAINLESS WITHOUT BUTTONS NOK 2.100		SYNTHETIC LEATHER STAINLESS WITH BUTTONS NOK 2.590	

BUTAQUE
 M 0,27 m³ 13,2 kgs

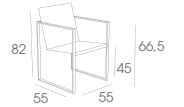

BUTAQUE TEAK
 M 0,27 m³ 12,0 kgs

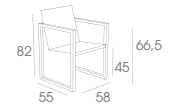

POLTRONA EASY CHAIR

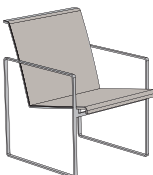

FRAME:		BRUSHED STAINLESS STEEL	ELECTRO POLISHED STAINLESS STEEL	POWDERCOATED STAINLESS STEEL WHITE	POWDERCOATED STAINLESS STEEL CENDRE	POWDERCOATED STAINLESS STEEL BLACK	TEAK
SEAT:							
BATYLINE®	WHITE	NOK 5.650 PTNWU	NOK 6.550 PTNEPWU	-	-	-	-
	CENDRE	NOK 5.650 PTNCE	NOK 6.550 PTNEPCE	-	-	-	-
	BLACK	NOK 5.650 PTNZU	NOK 6.550 PTNEPZU	-	-	-	-

POLTRONA
 M 0,41 m³ 16,0 kgs

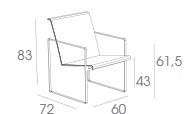

PRODUCT

PRICES & REFERENCES

SPECS

POLTRONA TRES
SOFA

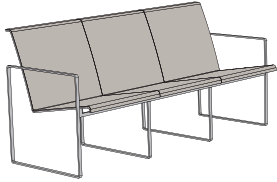

FRAME:		BRUSHED STAINLESS STEEL	ELECTRO POLISHED STAINLESS STEEL	POWDERCOATED STAINLESS STEEL WHITE	POWDERCOATED STAINLESS STEEL CENDRE	POWDERCOATED STAINLESS STEEL BLACK	TEAK
SEAT:							
BATYLINE®	WHITE	NOK 15.500 PTTWU	NOK 16.500 PTTEPWU	-	-	-	-
	CENDRE	NOK 15.500 PTTCE	NOK 16.500 PTTEPCE	-	-	-	-
	BLACK	NOK 15.500 PTTZU	NOK 16.500 PTTEPZU	-	-	-	-



ESCABEL
FOOTREST

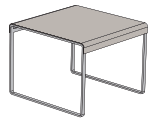

FRAME:		BRUSHED STAINLESS STEEL	ELECTRO POLISHED STAINLESS STEEL	POWDERCOATED STAINLESS STEEL WHITE	POWDERCOATED STAINLESS STEEL CENDRE	POWDERCOATED STAINLESS STEEL BLACK	TEAK
SEAT:							
BATYLINE®	WHITE	NOK 3.400 ESBWU	NOK 3.900 ESBEPWU	-	-	-	-
	CENDRE	NOK 3.400 ESBCE	NOK 3.900 ESBEPCE	-	-	-	-
	BLACK	NOK 3.400 ESBZU	NOK 3.900 ESBEPZU	-	-	-	-



TUMBONA
LOUNGER
- FIXED POSITION

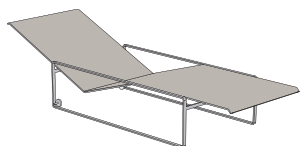

FRAME:		BRUSHED STAINLESS STEEL	ELECTRO POLISHED STAINLESS STEEL	POWDERCOATED STAINLESS STEEL WHITE	POWDERCOATED STAINLESS STEEL CENDRE	POWDERCOATED STAINLESS STEEL BLACK	TEAK
SEAT:							
BATYLINE®	WHITE	NOK 8.900 TBNWU	NOK 9.900 TBNEPWU	-	-	-	-
	CENDRE	NOK 8.900 TBNCE	NOK 9.900 TBNEPCE	-	-	-	-
	BLACK	NOK 8.900 TBNZU	NOK 9.900 TBNEPZU	-	-	-	-



PRODUCT

PRICES & REFERENCES

SPECS

TABURETE
BARSTOOL



SEAT:		FRAME:						
		BRUSHED STAINLESS STEEL	ELECTRO POLISHED STAINLESS STEEL	POWDERCOATED STAINLESS STEEL WHITE	POWDERCOATED STAINLESS STEEL CENDRE	POWDERCOATED STAINLESS STEEL BLACK	TEAK	
BATYLINE®								
WHITE		NOK 5.290 TBRWU	NOK 5.890 TBREPWU	-	-	-	-	-
CENDRE		NOK 5.290 TBRCE	NOK 5.890 TBREPCE	-	-	-	-	-
BLACK		NOK 5.290 TBRZU	NOK 5.890 TBREPZU	-	-	-	-	-

TABURETE

M³ 0,21 m³ P 15,8 kgs

PEQUEÑA
SIDE TABLE



TOP:		BASE:				
		STAINLESS STEEL BRUSHED	STAINLESS STEEL ELECTRO POLISHED (EP)	STAINLESS STEEL POWDERCOATED FINISH WHITE (WUL)	STAINLESS STEEL POWDERCOATED FINISH CENDRE (CAU)	STAINLESS STEEL POWDERCOATED FINISH BLACK (ZUL)
GLASS 10 mm						
WHITE		NOK 4.490 PQNGWU	NOK 4.690 PQNGEPWU	-	-	-
CENDRE		NOK 4.490 PQNGCLU	NOK 4.690 PQNGEPCLU	-	-	-
BLACK		NOK 4.490 PQNGZU	NOK 4.690 PQNGEPZU	-	-	-
CERAMIC 10 mm						
WHITE		NOK 4.950 PQNCWU	NOK 5.150 PQNCEPWU	-	-	-
CENDRE		NOK 4.950 PQNCCLU	NOK 5.150 PQNCEPCLU	-	-	-
BLACK		NOK 4.950 PQNCZU	NOK 5.150 PQNCEPZU	-	-	-
TEAK 20 mm						
TEAK		NOK 3.450 PQNT	NOK 3.650 PQNTEP	-	-	-
BLUESTONE 20 mm						
BLUESTONE		NOK 4.490 PQNA	NOK 4.690 PQNAEP	-	-	-

PEQUEÑA GLASS

M³ 0,16 m³ P 11,2 kgs

PEQUEÑA CERAMIC

M³ 0,16 m³ P 11,2 kgs

PEQUEÑA TEAK

M³ 0,16 m³ P 10,2 kgs

PEQUEÑA BLUESTONE

M³ 0,16 m³ P 18,8 kgs

PRODUCT

PRICES & REFERENCES

SPECS

MESONA 50
SIDE TABLE

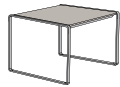

TOP:		BASE:		STAINLESS STEEL BRUSHED	STAINLESS STEEL ELECTRO POLISHED (EP)	STAINLESS STEEL POWDERCOATED FINISH WHITE (WUL)	STAINLESS STEEL POWDERCOATED FINISH CENDRE (CAU)	STAINLESS STEEL POWDERCOATED FINISH BLACK (ZUL)
GLASS 10 mm	WHITE			NOK 6.500 MSN50GWU	NOK 6.900 MSN50GEPWU	-	-	-
	CENDRE			NOK 6.500 MSN50GCLU	NOK 6.900 MSN50GEPCLU	-	-	-
	BLACK			NOK 6.500 MSN50GZU	NOK 6.900 MSN50GEPZU	-	-	-
CERAMIC 10 mm	WHITE			NOK 8.500 MSN50CWU	NOK 8.900 MSN50CEPWU	-	-	-
	CENDRE			NOK 8.500 MSN50CCLU	NOK 8.900 MSN50CEPCLU	-	-	-
	BLACK			NOK 8.500 MSN50CZU	NOK 8.900 MSN50CEPZU	-	-	-
TEAK 20 mm	TEAK			NOK 6.250 MSN50T	NOK 6.650 MSN50TEP	-	-	-

MESONA 50 GLASS
 0,15 m³ 12,4 kgs

MESONA 50 CERAMIC
 0,15 m³ 12,4 kgs

MESONA 50 TEAK
 0,15 m³ 11,4 kgs

MESONA 142
SALON TABLE

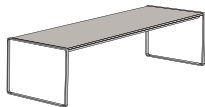

TOP:		BASE:		STAINLESS STEEL BRUSHED	STAINLESS STEEL ELECTRO POLISHED (EP)	STAINLESS STEEL POWDERCOATED FINISH WHITE (WUL)	STAINLESS STEEL POWDERCOATED FINISH CENDRE (CAU)	STAINLESS STEEL POWDERCOATED FINISH BLACK (ZUL)
GLASS 10 mm	WHITE			NOK 12.000 MSN142GWU	NOK 14.000 MSN142GEPWU	-	-	-
	CENDRE			NOK 12.000 MSN142GCLU	NOK 14.000 MSN142GEPCLU	-	-	-
	BLACK			NOK 12.000 MSN142GZU	NOK 14.000 MSN142GEPZU	-	-	-
CERAMIC 10 mm	WHITE			NOK 13.200 MSN142CWU	NOK 15.200 MSN142CEPWU	-	-	-
	CENDRE			NOK 13.200 MSN142CCLU	NOK 15.200 MSN142CEPCLU	-	-	-
	BLACK			NOK 13.200 MSN142CZU	NOK 15.200 MSN142CEPZU	-	-	-
TEAK 20 mm	TEAK			NOK 12.000 MSN142T	NOK 14.000 MSN142TEP	-	-	-

MESONA 142 GLASS
 0,41 m³ 36,7 kgs

MESONA 142 CERAMIC
 0,41 m³ 36,7 kgs

MESONA 142 TEAK
 0,41 m³ 34,1 kgs

PRODUCT

NIMIO BAR 60
BISTRO TABLE

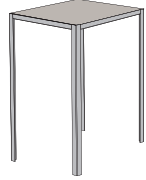

PRICES & REFERENCES

BASE:		STAINLESS STEEL BRUSHED	STAINLESS STEEL ELECTRO POLISHED (EP)	STAINLESS STEEL POWDERCOATED FINISH WHITE (WUL)	STAINLESS STEEL POWDERCOATED FINISH CENDRE (CAU)	STAINLESS STEEL POWDERCOATED FINISH BLACK (ZUL)
TOP:	GLASS 10 mm					
	WHITE	NOK 13.000 NMB60GWU	NOK 15.000 NMB60GEPWU	NOK 15.000 NMB60GWULWU	NOK 15.000 NMB60GCAUWU	NOK 15.000 NMB60GZULWU
	CENDRE	NOK 13.000 NMB60GCLU	NOK 15.000 NMB60GEPCLU	NOK 15.000 NMB60GWULCLU	NOK 15.000 NMB60GCAUCLU	NOK 15.000 NMB60GZULCLU
	BLACK	NOK 13.000 NMB60GZU	NOK 15.000 NMB60GEPZU	NOK 15.000 NMB60GWULZU	NOK 15.000 NMB60GCAUZU	NOK 15.000 NMB60GZULZU
	CERAMIC 10 mm					
	WHITE	NOK 14.300 NMB60CWU	NOK 16.500 NMB60CEPWU	NOK 16.500 NMB60CWULWU	NOK 16.500 NMB60CCAUWU	NOK 16.500 NMB60CZULWU
	CENDRE	NOK 14.300 NMB60CCLU	NOK 16.500 NMB60CEPCLU	NOK 16.500 NMB60CWULCLU	NOK 16.500 NMB60CCAUCLU	NOK 16.500 NMB60CZULCLU
	BLACK	NOK 14.300 NMB60CZU	NOK 16.500 NMB60CEPZU	NOK 16.500 NMB60CWULZU	NOK 16.500 NMB60CCAUZU	NOK 16.500 NMB60CZULZU
	BLUESTONE 20 mm					
	BLUESTONE	NOK 14.800 NMB60A	NOK 16.800 NMB60AEP	NOK 16.800 NMB60AWUL	NOK 16.800 NMB60ACAU	NOK 16.800 NMB60AZUL

SPECS

NIMIO BAR 60 GLASS
M³ 0,39 m³ K^g 38,7 kgs

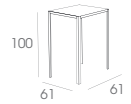

NIMIO BAR 60 CERAMIC
M³ 0,39 m³ K^g 38,7 kgs

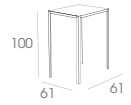

NIMIO BAR 60 BLUESTONE
M³ 0,39 m³ K^g 67,5 kgs

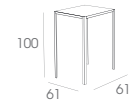

NIMIO BAR 140
BAR TABLE

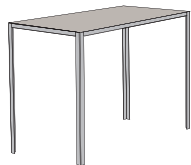

BASE:		STAINLESS STEEL BRUSHED	STAINLESS STEEL ELECTRO POLISHED (EP)	STAINLESS STEEL POWDERCOATED FINISH WHITE (WUL)	STAINLESS STEEL POWDERCOATED FINISH CENDRE (CAU)	STAINLESS STEEL POWDERCOATED FINISH BLACK (ZUL)
TOP:	GLASS 10 mm					
	WHITE	NOK 17.000 NMB140GWU	NOK 19.000 NMB140GEPWU	NOK 19.000 NMB140GWULWU	NOK 19.000 NMB140GCAUWU	NOK 19.000 NMB140GZULWU
	CENDRE	NOK 17.000 NMB140GCLU	NOK 19.000 NMB140GEPCLU	NOK 19.000 NMB140GWULCLU	NOK 19.000 NMB140GCAUCLU	NOK 19.000 NMB140GZULCLU
	BLACK	NOK 17.000 NMB140GZU	NOK 19.000 NMB140GEPZU	NOK 19.000 NMB140GWULZU	NOK 19.000 NMB140GCAUZU	NOK 19.000 NMB140GZULZU
	CERAMIC 10 mm					
	WHITE	NOK 18.700 NMB140CWU	NOK 20.900 NMB140CEPWU	NOK 20.900 NMB140CWULWU	NOK 20.900 NMB140CCAUWU	NOK 20.900 NMB140CZULWU
	CENDRE	NOK 18.700 NMB140CCLU	NOK 20.900 NMB140CEPCLU	NOK 20.900 NMB140CWULCLU	NOK 20.900 NMB140CCAUCLU	NOK 20.900 NMB140CZULCLU
	BLACK	NOK 18.700 NMB140CZU	NOK 20.900 NMB140CEPZU	NOK 20.900 NMB140CWULZU	NOK 20.900 NMB140CCAUZU	NOK 20.900 NMB140CZULZU
	TEAK 20 mm					
	TEAK	NOK 17.000 NMB140T	NOK 19.000 NMB140TEP	NOK 19.000 NMB140TWUL	NOK 19.000 NMB140TCAU	NOK 19.000 NMB140TZUL
	BLUESTONE 20 mm					
	BLUESTONE	NOK 18.900 NMB140A	NOK 21.900 NMB140AEP	NOK 21.900 NMB140AWUL	NOK 21.900 NMB140ACAU	NOK 21.900 NMB140AZUL

NIMIO BAR 140 GLASS
M³ 0,96 m³ K^g 43,2 kgs

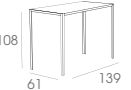

NIMIO BAR 140 CERAMIC
M³ 0,96 m³ K^g 43,2 kgs

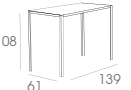

NIMIO BAR 140 TEAK
M³ 0,96 m³ K^g 40,3 kgs

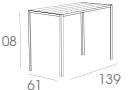

NIMIO BAR 140 BLUESTONE
M³ 1,02 m³ K^g 82,8 kgs

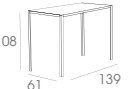

PRODUCT

PRICES & REFERENCES

SPECS

NIMIO BAR 190
BAR TABLE



BASE:		TOP:				
		GLASS 10 mm	CERAMIC 10 mm	TEAK 20 mm	BLUESTONE 20 mm	
WHITE CENDRE BLACK WHITE CENDRE BLACK TEAK BLUESTONE	STAINLESS STEEL BRUSHED	NOK 19.950 NMB190GWU	NOK 22.900 NMB190GEPWU	NOK 22.900 NMB190GWULWU	NOK 22.900 NMB190GCAUWU	NOK 22.900 NMB190GZULWU
	STAINLESS STEEL ELECTRO POLISHED (EP)	NOK 19.950 NMB190GCLU	NOK 22.900 NMB190GEPCLU	NOK 22.900 NMB190GWULCLU	NOK 22.900 NMB190GCAUCLU	NOK 22.900 NMB190GZULCLU
	STAINLESS STEEL POWDERCOATED FINISH WHITE (WUL)	NOK 19.950 NMB190GZU	NOK 22.900 NMB190GEPZU	NOK 22.900 NMB190GWULZU	NOK 22.900 NMB190GCAUZU	NOK 22.900 NMB190GZULZU
	STAINLESS STEEL POWDERCOATED FINISH CENDRE (CAU)	NOK 21.950 NMB190CWU	NOK 25.190 NMB190CEPWU	NOK 25.190 NMB190CWULWU	NOK 25.190 NMB190CCAUWU	NOK 25.190 NMB190CZULWU
	STAINLESS STEEL POWDERCOATED FINISH BLACK (ZUL)	NOK 21.950 NMB190CCLU	NOK 25.190 NMB190CEPCLU	NOK 25.190 NMB190CWULCLU	NOK 25.190 NMB190CCAUCLU	NOK 25.190 NMB190CZULCLU
		NOK 21.950 NMB190CZU	NOK 25.190 NMB190CEPZU	NOK 25.190 NMB190CWULZU	NOK 25.190 NMB190CCAUZU	NOK 25.190 NMB190CZULZU
		NOK 21.000 NMB190T	NOK 23.000 NMB190TEP	NOK 23.000 NMB190TWUL	NOK 23.000 NMB190TCAU	NOK 23.000 NMB190TZUL
		NOK 21.950 NMB190A	NOK 25.190 NMB190AEP	NOK 25.190 NMB190AWUL	NOK 25.190 NMB190ACAU	NOK 25.190 NMB190AZUL

NIMIO BAR 190 GLASS
1,32 m³ 56,6 kgs

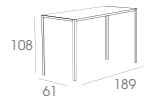

NIMIO BAR 190 CERAMIC
1,32 m³ 56,6 kgs

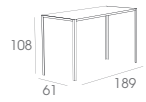

NIMIO BAR 190 TEAK
1,32 m³ 53,4 kgs

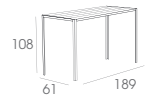

NIMIO BAR 190 BLUESTONE
1,42 m³ 106,5 kgs

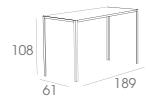

NIMIO 100
TABLE

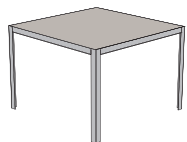

BASE:		TOP:				
		GLASS 10 mm	CERAMIC 10 mm	TEAK 20 mm	BLUESTONE 20 mm	
WHITE CENDRE BLACK WHITE CENDRE BLACK BLUESTONE	STAINLESS STEEL BRUSHED	NOK 20.950 NMO100GWU	NOK 21.950 NMO100GEPWU	NOK 21.950 NMO100GWULWU	NOK 21.950 NMO100GCAUWU	NOK 21.950 NMO100GZULWU
	STAINLESS STEEL ELECTRO POLISHED (EP)	NOK 20.950 NMO100GCLU	NOK 21.950 NMO100GEPCLU	NOK 21.950 NMO100GWULCLU	NOK 21.950 NMO100GCAUCLU	NOK 21.950 NMO100GZULCLU
	STAINLESS STEEL POWDERCOATED FINISH WHITE (WUL)	NOK 20.950 NMO100GZU	NOK 21.950 NMO100GEPZU	NOK 21.950 NMO100GWULZU	NOK 21.950 NMO100GCAUZU	NOK 21.950 NMO100GZULZU
	STAINLESS STEEL POWDERCOATED FINISH CENDRE (CAU)	NOK 23.050 NMO100CWU	NOK 24.150 NMO100CEPWU	NOK 24.150 NMO100CWULWU	NOK 24.150 NMO100CCAUWU	NOK 24.150 NMO100CZULWU
	STAINLESS STEEL POWDERCOATED FINISH BLACK (ZUL)	NOK 23.050 NMO100CCLU	NOK 24.150 NMO100CEPCLU	NOK 24.150 NMO100CWULCLU	NOK 24.150 NMO100CCAUCLU	NOK 24.150 NMO100CZULCLU
		NOK 23.050 NMO100CZU	NOK 24.150 NMO100CEPZU	NOK 24.150 NMO100CWULZU	NOK 24.150 NMO100CCAUZU	NOK 24.150 NMO100CZULZU
		NOK 23.500 NMO100A	NOK 24.500 NMO100AEP	NOK 24.500 NMO100AWUL	NOK 24.500 NMO100ACAU	NOK 24.500 NMO100AZUL

NIMIO 100 GLASS
0,77 m³ 79,6 kgs

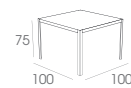

NIMIO 100 CERAMIC
0,77 m³ 79,6 kgs

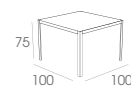

NIMIO 100 BLUESTONE
0,89 m³ 137,4 kgs

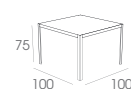

PRODUCT

NIMIO 140
TABLE

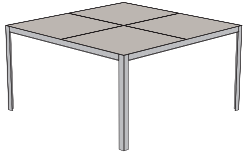

PRICES & REFERENCES

BASE:		STAINLESS STEEL BRUSHED	STAINLESS STEEL ELECTRO POLISHED (EP)	STAINLESS STEEL POWDERCOATED FINISH WHITE (WUL)	STAINLESS STEEL POWDERCOATED FINISH CENDRE (CAU)	STAINLESS STEEL POWDERCOATED FINISH BLACK (ZUL)
TOP:	GLASS 10 mm					
	WHITE	NOK 24.000 NMO140GWU	NOK 25.950 NMO140GEPWU	NOK 25.950 NMO140GWULWU	NOK 25.950 NMO140GCAUWU	NOK 25.950 NMO140GZULWU
	CENDRE	NOK 24.000 NMO140GCLU	NOK 25.950 NMO140GEPCLU	NOK 25.950 NMO140GWULCLU	NOK 25.950 NMO140GCAUCLU	NOK 25.950 NMO140GZULCLU
	BLACK	NOK 24.000 NMO140GZU	NOK 25.950 NMO140GEPZU	NOK 25.950 NMO140GWULZU	NOK 25.950 NMO140GCAUZU	NOK 25.950 NMO140GZULZU
	CERAMIC 10 mm					
	WHITE	NOK 26.400 NMO140CWU	NOK 28.550 NMO140CEPWU	NOK 28.550 NMO140CWULWU	NOK 28.550 NMO140CCAUWU	NOK 28.550 NMO140CZULWU
	CENDRE	NOK 26.400 NMO140CCLU	NOK 28.550 NMO140CEPCLU	NOK 28.550 NMO140CWULCLU	NOK 28.550 NMO140CCAUCLU	NOK 28.550 NMO140CZULCLU
	BLACK	NOK 26.400 NMO140CZU	NOK 28.550 NMO140CEPZU	NOK 28.550 NMO140CWULZU	NOK 28.550 NMO140CCAUZU	NOK 28.550 NMO140CZULZU
	TEAK 20 mm					
	TEAK	NOK 22.000 NMO140T	NOK 24.000 NMO140TEP	NOK 24.000 NMO140TWUL	NOK 24.000 NMO140TCAU	NOK 24.000 NMO140TZUL
	BLUESTONE 20 mm					
	BLUESTONE	NOK 28.900 NMO140A	NOK 29.500 NMO140AEP	NOK 29.500 NMO140AWUL	NOK 29.500 NMO140ACAU	NOK 29.500 NMO140AZUL

SPECS

- NIMIO 140 GLASS
M³ 1,69 m³ P 99,5 kgs
- NIMIO 140 CERAMIC
M³ 1,69 m³ P 99,5 kgs
- NIMIO 140 TEAK
M³ 1,69 m³ P 82,3 kgs
- NIMIO 140 BLUESTONE
M³ 1,69 m³ P 174,0 kgs

NIMIO 200
TABLE

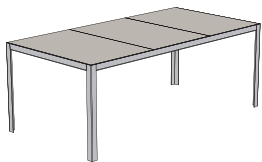

BASE:		STAINLESS STEEL BRUSHED	STAINLESS STEEL ELECTRO POLISHED (EP)	STAINLESS STEEL POWDERCOATED FINISH WHITE (WUL)	STAINLESS STEEL POWDERCOATED FINISH CENDRE (CAU)	STAINLESS STEEL POWDERCOATED FINISH BLACK (ZUL)
TOP:	GLASS 10 mm					
	WHITE	NOK 24.000 NMO200GWU	NOK 25.950 NMO200GEPWU	NOK 25.950 NMO200GWULWU	NOK 25.950 NMO200GCAUWU	NOK 25.950 NMO200GZULWU
	CENDRE	NOK 24.000 NMO200GCLU	NOK 25.950 NMO200GEPCLU	NOK 25.950 NMO200GWULCLU	NOK 25.950 NMO200GCAUCLU	NOK 25.950 NMO200GZULCLU
	BLACK	NOK 24.000 NMO200GZU	NOK 25.950 NMO200GEPZU	NOK 25.950 NMO200GWULZU	NOK 25.950 NMO200GCAUZU	NOK 25.950 NMO200GZULZU
	CERAMIC 10 mm					
	WHITE	NOK 26.400 NMO200CWU	NOK 28.550 NMO200CEPWU	NOK 28.550 NMO200CWULWU	NOK 28.550 NMO200CCAUWU	NOK 28.550 NMO200CZULWU
	CENDRE	NOK 26.400 NMO200CCLU	NOK 28.550 NMO200CEPCLU	NOK 28.550 NMO200CWULCLU	NOK 28.550 NMO200CCAUCLU	NOK 28.550 NMO200CZULCLU
	BLACK	NOK 26.400 NMO200CZU	NOK 28.550 NMO200CEPZU	NOK 28.550 NMO200CWULZU	NOK 28.550 NMO200CCAUZU	NOK 28.550 NMO200CZULZU
	TEAK 20 mm					
	TEAK	NOK 22.000 NMO200T	NOK 24.000 NMO200TEP	NOK 24.000 NMO200TWUL	NOK 24.000 NMO200TCAU	NOK 24.000 NMO200TZUL
	BLUESTONE 20 mm					
	BLUESTONE	NOK 28.900 NMO200A	NOK 29.500 NMO200AEP	NOK 29.500 NMO200AWUL	NOK 29.500 NMO200ACAU	NOK 29.500 NMO200AZUL

- NIMIO 200 GLASS
M³ 1,70 m³ P 90,8 kgs
- NIMIO 200 CERAMIC
M³ 1,70 m³ P 90,8 kgs
- NIMIO 200 TEAK
M³ 1,70 m³ P 81,7 kgs
- NIMIO 200 BLUESTONE
M³ 1,70 m³ P 183,9 kgs

PRODUCT

NIMIO 260
TABLE

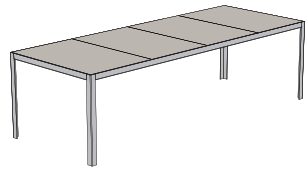

PRICES & REFERENCES

BASE:		STAINLESS STEEL BRUSHED	STAINLESS STEEL ELECTRO POLISHED (EP)	STAINLESS STEEL POWDERCOATED FINISH WHITE (WUL)	STAINLESS STEEL POWDERCOATED FINISH CENDRE (CAU)	STAINLESS STEEL POWDERCOATED FINISH BLACK (ZUL)
TOP:	GLASS 10 mm					
	WHITE	NOK 32.000 NMO260GWU	NOK 33.950 NMO260GEPWU	NOK 33.950 NMO260GWULWU	NOK 33.950 NMO260GCAUWU	NOK 33.950 NMO260GZULWU
	CENDRE	NOK 32.000 NMO260GCLU	NOK 33.950 NMO260GEPCLU	NOK 33.950 NMO260GWULCLU	NOK 33.950 NMO260GCAUCLU	NOK 33.950 NMO260GZULCLU
	BLACK	NOK 32.000 NMO260GZU	NOK 33.950 NMO260GEPZU	NOK 33.950 NMO260GWULZU	NOK 33.950 NMO260GCAUZU	NOK 33.950 NMO260GZULZU
	CERAMIC 10 mm					
	WHITE	NOK 35.200 NMO260CWU	NOK 37.350 NMO260CEPWU	NOK 37.350 NMO260CWULWU	NOK 37.350 NMO260CCAUWU	NOK 37.350 NMO260CZULWU
	CENDRE	NOK 35.200 NMO260CCLU	NOK 37.350 NMO260CEPCLU	NOK 37.350 NMO260CWULCLU	NOK 37.350 NMO260CCAUCLU	NOK 37.350 NMO260CZULCLU
	BLACK	NOK 35.200 NMO260CZU	NOK 37.350 NMO260CEPZU	NOK 37.350 NMO260CWULZU	NOK 37.350 NMO260CCAUZU	NOK 37.350 NMO260CZULZU
	TEAK 20 mm					
	TEAK	NOK 28.000 NMO260T	NOK 29.500 NMO260TEP	NOK 29.500 NMO260TWUL	NOK 29.500 NMO260TCAU	NOK 29.500 NMO260TZUL
	BLUESTONE 20 mm					
	BLUESTONE	NOK 35.500 NMO260A	NOK 37.900 NMO260AEP	NOK 37.900 NMO260AWUL	NOK 37.900 NMO260ACAU	NOK 37.900 NMO260AZUL

SPECS

NIMIO 260 GLASS
M 2,26 m³ 122,7 kgs
75 100 260

NIMIO 260 CERAMIC
M 2,26 m³ 122,7 kgs
75 100 260

NIMIO 260 TEAK
M 2,26 m³ 110,5 kgs
75 100 260

NIMIO 260 BLUESTONE
M 2,26 m³ 231,2 kgs
75 100 260

NIMIO 325
TABLE

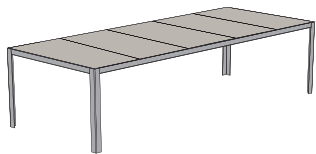

BASE:		STAINLESS STEEL BRUSHED	STAINLESS STEEL ELECTRO POLISHED (EP)	STAINLESS STEEL POWDERCOATED FINISH WHITE (WUL)	STAINLESS STEEL POWDERCOATED FINISH CENDRE (CAU)	STAINLESS STEEL POWDERCOATED FINISH BLACK (ZUL)
TOP:	GLASS 10 mm					
	WHITE	NOK 43.950 NMO325GWU	NOK 45.900 NMO325GEPWU	NOK 45.900 NMO325GWULWU	NOK 45.900 NMO325GCAUWU	NOK 45.900 NMO325GZULWU
	CENDRE	NOK 43.950 NMO325GCLU	NOK 45.900 NMO325GEPCLU	NOK 45.900 NMO325GWULCLU	NOK 45.900 NMO325GCAUCLU	NOK 45.900 NMO325GZULCLU
	BLACK	NOK 43.950 NMO325GZU	NOK 45.900 NMO325GEPZU	NOK 45.900 NMO325GWULZU	NOK 45.900 NMO325GCAUZU	NOK 45.900 NMO325GZULZU
	CERAMIC 10 mm					
	WHITE	NOK 48.350 NMO325CWU	NOK 49.950 NMO325CEPWU	NOK 49.950 NMO325CWULWU	NOK 49.950 NMO325CCAUWU	NOK 49.950 NMO325CZULWU
	CENDRE	NOK 48.350 NMO325CCLU	NOK 49.950 NMO325CEPCLU	NOK 49.950 NMO325CWULCLU	NOK 49.950 NMO325CCAUCLU	NOK 49.950 NMO325CZULCLU
	BLACK	NOK 48.350 NMO325CZU	NOK 49.950 NMO325CEPZU	NOK 49.950 NMO325CWULZU	NOK 49.950 NMO325CCAUZU	NOK 49.950 NMO325CZULZU
	TEAK 20 mm					
	TEAK	NOK 34.500 NMO325T	NOK 36.500 NMO325TEP	NOK 36.500 NMO325TWUL	NOK 36.500 NMO325TCAU	NOK 36.500 NMO325TZUL

NIMIO 325 GLASS
M 1,70 m³ 90,8 kgs
75 100 325

NIMIO 325 CERAMIC
M 1,70 m³ 90,8 kgs
75 100 325

NIMIO 325 TEAK
M 1,70 m³ 81,7 kgs
75 100 325

PRODUCT

DOBLE BENCH 160
BENCH

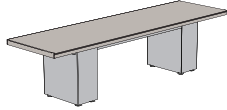

PRICES & REFERENCES

BASE:		BRUSHED STAINLESS STEEL	ELECTRO POLISHED STAINLESS STEEL	POWDERCOATED STAINLESS STEEL WHITE	POWDERCOATED STAINLESS STEEL CENDRE	POWDERCOATED STAINLESS STEEL BLACK
SEAT:						
BATYLINE®						
	WHITE	NOK 14.900 DBB160WU	NOK 16.900 DBB160EPWU	NOK 16.900 DBB160WULWU	-	-
	CENDRE	NOK 14.900 DBB160CE	NOK 16.900 DBB160EPCE	-	NOK 16.900 DBB160CAUCE	-
	BLACK	NOK 14.900 DBB160ZU	NOK 16.900 DBB160EPZU	-	-	NOK 16.900 DBB160ZULZU
TEAK	TEAK	NOK 11.900 DBB160T	NOK 12.900 DBB160TEP	NOK 12.900 DBB160TWUL	NOK 12.900 DBB160TCAU	NOK 12.900 DBB160TZUL
CUSHION		STANDARD TEMPOTEST® FABRIC NOK 2.600 FOR MORE INFORMATION ABOUT CUSHIONS SEE PAGE 14	SYNTHETIC LEATHER STAMSKIN® WITHOUT BUTTONS NOK 3.500	SYNTHETIC LEATHER STAMSKIN® WITH BUTTONS NOK 4.050		

SPECS

DOBLE BENCH 160
M³ 0,22 m³ P 37,4 kgs

DOBLE BENCH 160 TEAK
M³ 0,22 m³ P 31,2 kgs

DOBLE BENCH 240
BENCH

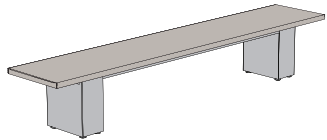

BASE:		BRUSHED STAINLESS STEEL	ELECTRO POLISHED STAINLESS STEEL	POWDERCOATED STAINLESS STEEL WHITE	POWDERCOATED STAINLESS STEEL CENDRE	POWDERCOATED STAINLESS STEEL BLACK
SEAT:						
BATYLINE®						
	WHITE	NOK 18.900 DBB240WU	NOK 21.900 DBB240EPWU	NOK 21.900 DBB240WULWU	-	-
	CENDRE	NOK 18.900 DBB240CE	NOK 21.900 DBB240EPCE	-	NOK 21.900 DBB240CAUCE	-
	BLACK	NOK 18.900 DBB240ZU	NOK 21.900 DBB240EPZU	-	-	NOK 21.900 DBB240ZULZU
TEAK	TEAK	NOK 15.900 DBB240T	NOK 16.900 DBB240TEP	NOK 16.900 DBB240TWUL	NOK 16.900 DBB240TCAU	NOK 16.900 DBB240TZUL
CUSHION		STANDARD TEMPOTEST® FABRIC NOK 3.500 FOR MORE INFORMATION ABOUT CUSHIONS SEE PAGE 14	SYNTHETIC LEATHER STAMSKIN® WITHOUT BUTTONS NOK 5.200	SYNTHETIC LEATHER STAMSKIN® WITH BUTTONS NOK 5.600		

DOBLE BENCH 240
M³ 0,36 m³ P 48,0 kgs

DOBLE BENCH 240 TEAK
M³ 0,36 m³ P 40,4 kgs

PRODUCT

DOBLE 160
TABLE

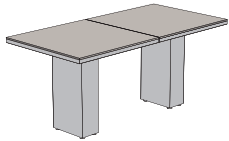

BASE:		STAINLESS STEEL BRUSHED	STAINLESS STEEL ELECTRO POLISHED (EP)	STAINLESS STEEL POWDERCOATED FINISH WHITE (WUL)	STAINLESS STEEL POWDERCOATED FINISH CENDRE (CAU)	STAINLESS STEEL POWDERCOATED FINISH BLACK (ZUL)
TOP:	GLASS 10 mm					
	WHITE	NOK 27.500 DBL160GWU	NOK 29.500 DBL160GEPWU	NOK 29.500 DBL160GWULWU	NOK 29.500 DBL160GCAUWU	NOK 29.500 DBL160GZULWU
	CENDRE	NOK 27.500 DBL160GCLU	NOK 29.500 DBL160GEPCLU	NOK 29.500 DBL160GWULCLU	NOK 29.500 DBL160GCAUCLU	NOK 29.500 DBL160GZULCLU
	BLACK	NOK 27.500 DBL160GZU	NOK 29.500 DBL160GEPZU	NOK 29.500 DBL160GWULZU	NOK 29.500 DBL160GCAUZU	NOK 29.500 DBL160GZULZU
	CERAMIC 10 mm					
	WHITE	NOK 29.950 DBL160CWU	NOK 32.450 DBL160CEPWU	NOK 32.450 DBL160CWULWU	NOK 32.450 DBL160CCAUWU	NOK 32.450 DBL160CZULWU
	CENDRE	NOK 29.950 DBL160CCLU	NOK 32.450 DBL160CEPCLU	NOK 32.450 DBL160CWULCLU	NOK 32.450 DBL160CCAUCLU	NOK 32.450 DBL160CZULCLU
	BLACK	NOK 29.950 DBL160CZU	NOK 32.450 DBL160CEPZU	NOK 32.450 DBL160CWULZU	NOK 32.450 DBL160CCAUZU	NOK 32.450 DBL160CZULZU
	TEAK 40 mm					
	TEAK	NOK 23.500 DBL160T	NOK 24.950 DBL160TEP	NOK 24.950 DBL160TWUL	NOK 24.950 DBL160TCAU	NOK 24.950 DBL160TZUL
	BLUESTONE 40 mm					
	BLUESTONE	NOK 31.000 DBL160A	NOK 32.950 DBL160AEP	NOK 32.950 DBL160AWUL	NOK 32.950 DBL160ACAU	NOK 32.950 DBL160AZUL

SPECS

DOBLE 160 GLASS

 0,45 m³ 83,1 kgs

DOBLE 160 CERAMIC

 0,45 m³ 83,1 kgs

DOBLE 160 TEAK

 0,36 m³ 68,7 kgs

DOBLE 160 BLUESTONE

 0,52 m³ 191,7 kgs

DOBLE 180
TABLE

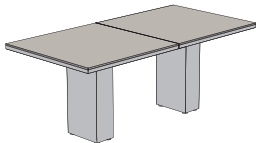

BASE:		STAINLESS STEEL BRUSHED	STAINLESS STEEL ELECTRO POLISHED (EP)	STAINLESS STEEL POWDERCOATED FINISH WHITE (WUL)	STAINLESS STEEL POWDERCOATED FINISH CENDRE (CAU)	STAINLESS STEEL POWDERCOATED FINISH BLACK (ZUL)
TOP:	GLASS 10 mm					
	WHITE	NOK 27.950 DBL180GWU	NOK 30.950 DBL180GEPWU	NOK 30.950 DBL180GWULWU	NOK 30.950 DBL180GCAUWU	NOK 30.950 DBL180GZULWU
	CENDRE	NOK 27.950 DBL180GCLU	NOK 30.950 DBL180GEPCLU	NOK 30.950 DBL180GWULCLU	NOK 30.950 DBL180GCAUCLU	NOK 30.950 DBL180GZULCLU
	BLACK	NOK 27.950 DBL180GZU	NOK 30.950 DBL180GEPZU	NOK 30.950 DBL180GWULZU	NOK 30.950 DBL180GCAUZU	NOK 30.950 DBL180GZULZU
	CERAMIC 10 mm					
	WHITE	NOK 30.750 DBL180CWU	NOK 33.950 DBL180CEPWU	NOK 33.950 DBL180CWULWU	NOK 33.950 DBL180CCAUWU	NOK 33.950 DBL180CZULWU
	CENDRE	NOK 30.750 DBL180CCLU	NOK 33.950 DBL180CEPCLU	NOK 33.950 DBL180CWULCLU	NOK 33.950 DBL180CCAUCLU	NOK 33.950 DBL180CZULCLU
	BLACK	NOK 30.750 DBL180CZU	NOK 33.950 DBL180CEPZU	NOK 33.950 DBL180CWULZU	NOK 33.950 DBL180CCAUZU	NOK 33.950 DBL180CZULZU
	TEAK 40 mm					
	TEAK	NOK 25.950 DBL180T	NOK 27.500 DBL180TEP	NOK 27.500 DBL180TWUL	NOK 27.500 DBL180TCAU	NOK 27.500 DBL180TZUL
	BLUESTONE 40 mm					
	BLUESTONE	NOK 34.950 DBL180A	NOK 36.500 DBL180AEP	NOK 36.500 DBL180AWUL	NOK 36.500 DBL180ACAU	NOK 36.500 DBL180AZUL

DOBLE 180 GLASS

 0,46 m³ 94,8 kgs

DOBLE 180 CERAMIC

 0,46 m³ 94,8 kgs

DOBLE 180 TEAK

 0,38 m³ 78,8 kgs

DOBLE 180 BLUESTONE

 0,57 m³ 227,8 kgs

PRODUCT

PRICES & REFERENCES

SPECS

DOBLE 240
TABLE

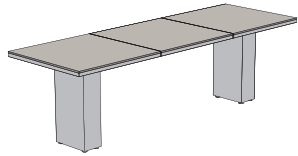

BASE:		STAINLESS STEEL BRUSHED	STAINLESS STEEL ELECTRO POLISHED (EP)	STAINLESS STEEL POWDERCOATED FINISH WHITE (WUL)	STAINLESS STEEL POWDERCOATED FINISH CENDRE (CAU)	STAINLESS STEEL POWDERCOATED FINISH BLACK (ZUL)
TOP:	GLASS 10 mm					
	WHITE	NOK 37.500 DBL240GWU	NOK 39.950 DBL240GEPWU	NOK 39.950 DBL240GWULWU	NOK 39.950 DBL240GCAUWU	NOK 39.950 DBL240GZULWU
	CENDRE	NOK 37.500 DBL240GCLU	NOK 39.950 DBL240GEPCLU	NOK 39.950 DBL240GWULCLU	NOK 39.950 DBL240GCAUCLU	NOK 39.950 DBL240GZULCLU
	BLACK	NOK 37.500 DBL240GZU	NOK 39.950 DBL240GEPZU	NOK 39.950 DBL240GWULZU	NOK 39.950 DBL240GCAUZU	NOK 39.950 DBL240GZULZU
	CERAMIC 10 mm					
	WHITE	NOK 41.250 DBL240CWU	NOK 43.950 DBL240CEPWU	NOK 43.950 DBL240CWULWU	NOK 43.950 DBL240CCAUWU	NOK 43.950 DBL240CZULWU
	CENDRE	NOK 41.250 DBL240CCLU	NOK 43.950 DBL240CEPCLU	NOK 43.950 DBL240CWULCLU	NOK 43.950 DBL240CCAUCLU	NOK 43.950 DBL240CZULCLU
	BLACK	NOK 41.250 DBL240CZU	NOK 43.950 DBL240CEPZU	NOK 43.950 DBL240CWULZU	NOK 43.950 DBL240CCAUZU	NOK 43.950 DBL240CZULZU
	TEAK 40 mm					
	TEAK	NOK 31.950 DBL240T	NOK 33.950 DBL240TEP	NOK 33.950 DBL240TWUL	NOK 33.950 DBL240TCAU	NOK 33.950 DBL240TZUL
	BLUESTONE 40 mm					
	BLUESTONE	NOK 41.500 DBL240A	NOK 43.950 DBL240AEP	NOK 43.950 DBL240AWUL	NOK 43.950 DBL240ACAU	NOK 43.950 DBL240AZUL

DOBLE 240 GLASS
M 0.75 m³ 112,9 kgs
75 80 240

DOBLE 240 CERAMIC
M 0.75 m³ 112,9 kgs
75 80 240

DOBLE 240 TEAK
M 0.63 m³ 91,3 kgs
75 80 240

DOBLE 240 BLUESTONE
M 0.79 m³ 264,3 kgs
75 80 240

DOBLE 240N
TABLE

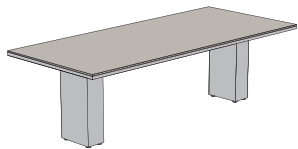

BASE:		STAINLESS STEEL BRUSHED	STAINLESS STEEL ELECTRO POLISHED (EP)	STAINLESS STEEL POWDERCOATED FINISH WHITE (WUL)	STAINLESS STEEL POWDERCOATED FINISH CENDRE (CAU)	STAINLESS STEEL POWDERCOATED FINISH BLACK (ZUL)
TOP:	GLASS 10 mm					
	WHITE	NOK 37.500 DBL240NGWU	NOK 39.950 DBL240NGEPWU	NOK 39.950 DBL240NGWULWU	NOK 39.950 DBL240NGCAUWU	NOK 39.950 DBL240NGZULWU
	CENDRE	NOK 37.500 DBL240NGCLU	NOK 39.950 DBL240NGEPCLU	NOK 39.950 DBL240NGWULCLU	NOK 39.950 DBL240NGCAUCLU	NOK 39.950 DBL240NGZULCLU
	BLACK	NOK 37.500 DBL240NGZU	NOK 39.950 DBL240NGEPZU	NOK 39.950 DBL240NGWULZU	NOK 39.950 DBL240NGCAUZU	NOK 39.950 DBL240NGZULZU
	CERAMIC 10 mm					
	WHITE	NOK 41.250 DBL240NCWU	NOK 43.950 DBL240NCEPWU	NOK 43.950 DBL240NCWULWU	NOK 43.950 DBL240NCCAUWU	NOK 43.950 DBL240NCZULWU
	CENDRE	NOK 41.250 DBL240NCCLU	NOK 43.950 DBL240NCEPCLU	NOK 43.950 DBL240NCWULCLU	NOK 43.950 DBL240NCCAUCLU	NOK 43.950 DBL240NCZULCLU
	BLACK	NOK 41.250 DBL240NCZU	NOK 43.950 DBL240NCEPZU	NOK 43.950 DBL240NCWULZU	NOK 43.950 DBL240NCCAUZU	NOK 43.950 DBL240NCZULZU
	TEAK 40 mm					
	TEAK	NOK 31.500 DBL240NT	NOK 33.500 DBL240NTEP	NOK 33.500 DBL240NTWUL	NOK 33.500 DBL240NTCAU	NOK 33.500 DBL240NTZUL

DOBLE 240N GLASS
M 0.46 m³ 94,8 kgs
75 100 240

DOBLE 240N CERAMIC
M 0.46 m³ 94,8 kgs
75 100 240

DOBLE 240N TEAK
M 0.38 m³ 78,8 kgs
75 100 240

PRODUCT

DOBLE 270
TABLE

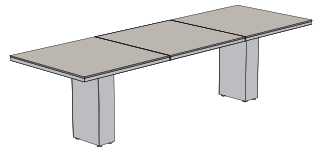

BASE:		STAINLESS STEEL BRUSHED	STAINLESS STEEL ELECTRO POLISHED (EP)	STAINLESS STEEL POWDERCOATED FINISH WHITE (WUL)	STAINLESS STEEL POWDERCOATED FINISH CENDRE (CAU)	STAINLESS STEEL POWDERCOATED FINISH BLACK (ZUL)
TOP:	GLASS 10 mm					
	WHITE	NOK 39.500 DBL270GWU	NOK 41.500 DBL270GEPWU	NOK 41.500 DBL270GWULWU	NOK 41.500 DBL270GCAUWU	NOK 41.500 DBL270GZULWU
	CENDRE	NOK 39.500 DBL270GCLU	NOK 41.500 DBL270GEPCLU	NOK 41.500 DBL270GWULCLU	NOK 41.500 DBL270GCAUCLU	NOK 41.500 DBL270GZULCLU
	BLACK	NOK 39.500 DBL270GZU	NOK 41.500 DBL270GEPZU	NOK 41.500 DBL270GWULZU	NOK 41.500 DBL270GCAUZU	NOK 41.500 DBL270GZULZU
	CERAMIC 10 mm					
	WHITE	NOK 43.500 DBL270CWU	NOK 45.650 DBL270CEPWU	NOK 45.650 DBL270CWULWU	NOK 45.650 DBL270CCAUWU	NOK 45.650 DBL270CZULWU
	CENDRE	NOK 43.500 DBL270CCLU	NOK 45.650 DBL270CEPCLU	NOK 45.650 DBL270CWULCLU	NOK 45.650 DBL270CCAUCLU	NOK 45.650 DBL270CZULCLU
	BLACK	NOK 43.500 DBL270CZU	NOK 45.650 DBL2700CEPZU	NOK 45.650 DBL270CWULZU	NOK 45.650 DBL270CCAUZU	NOK 45.650 DBL270CZULZU
	TEAK 40 mm					
	TEAK	NOK 34.950 DBL270T	NOK 37.500 DBL270TEP	NOK 37.500 DBL270TWUL	NOK 37.500 DBL270TCAU	NOK 37.500 DBL270TZUL
	BLUESTONE 40 mm					
	BLUESTONE	NOK 46.500 DBL270A	NOK 48.900 DBL270AEP	NOK 48.900 DBL270AWUL	NOK 48.900 DBL270ACAU	NOK 48.900 DBL270AZUL

SPECS

DOBLE 270 GLASS
M 0,78 m³ K 130,6 kgs

DOBLE 270 CERAMIC
M 0,78 m³ K 130,6 kgs

DOBLE 270 TEAK
M 0,66 m³ K 106,6 kgs

DOBLE 270 BLUESTONE
M 0,86 m³ K 321,6 kgs

DOBLE 300
TABLE

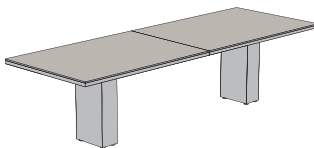

BASE:		STAINLESS STEEL BRUSHED	STAINLESS STEEL ELECTRO POLISHED (EP)	STAINLESS STEEL POWDERCOATED FINISH WHITE (WUL)	STAINLESS STEEL POWDERCOATED FINISH CENDRE (CAU)	STAINLESS STEEL POWDERCOATED FINISH BLACK (ZUL)
TOP:	GLASS 10 mm					
	WHITE	NOK 41.900 DBL300GWU	NOK 44.900 DBL300GEPWU	NOK 44.900 DBL300GWULWU	NOK 44.900 DBL300GCAUWU	NOK 44.900 DBL300GZULWU
	CENDRE	NOK 41.900 DBL300GCLU	NOK 44.900 DBL300GEPCLU	NOK 44.900 DBL300GWULCLU	NOK 44.900 DBL300GCAUCLU	NOK 44.900 DBL300GZULCLU
	BLACK	NOK 41.900 DBL300GZU	NOK 44.900 DBL300GEPZU	NOK 44.900 DBL300GWULZU	NOK 44.900 DBL300GCAUZU	NOK 44.900 DBL300GZULZU
	CERAMIC 10 mm					
	WHITE	NOK 45.950 DBL300CWU	NOK 49.500 DBL300CEPWU	NOK 49.500 DBL300CWULWU	NOK 49.500 DBL300CCAUWU	NOK 49.500 DBL300CZULWU
	CENDRE	NOK 45.950 DBL300CCLU	NOK 49.500 DBL300CEPCLU	NOK 49.500 DBL300CWULCLU	NOK 49.500 DBL300CCAUCLU	NOK 49.500 DBL300CZULCLU
	BLACK	NOK 45.950 DBL300CZU	NOK 49.500 DBL300CEPZU	NOK 49.500 DBL300CWULZU	NOK 49.500 DBL300CCAUZU	NOK 49.500 DBL300CZULZU
	TEAK 40 mm					
	TEAK	NOK 37.900 DBL300T	NOK 39.950 DBL300TEP	NOK 39.950 DBL300TWUL	NOK 39.950 DBL300TCAU	NOK 39.950 DBL300TZUL

DOBLE 300 GLASS
M 0,81 m³ K 140,8 kgs

DOBLE 300 CERAMIC
M 0,81 m³ K 140,8 kgs

DOBLE 300 TEAK
M 0,68 m³ K 122,2 kgs

CUSHIONS CIMA COLLECTION

PRODUCT

BUTAQUE CUSHION
SEAT + BACK CUSHION



VERSION:	COLOUR:				
	WHITE	CAPPUCHINO / CENDRE	GREY	BLACK	
STANDARD TEMPOTEST® FABRIC	NOK 1.590	PILBTQWU	PILBTQCAU	PILBTQROU	PILBTQZU
SYNTHETIC LEATHER STAMSKIN® WITHOUT BUTTONS	NOK 2.100	PILBTQVCWU	PILBTQVCCE	-	PILBTQVCZU
SYNTHETIC LEATHER STAMSKIN® WITH BUTTONS	NOK 2.590	PILBTQCWU	PILBTQCCE	-	PILBTQCZU

SPECS

CUSHION BUTAQUE

0,02 m³ 1,8 kgs

DOBLE BENCH 160 CUSHION
CUSHION

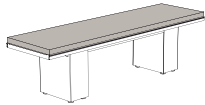

VERSION:	COLOUR:				
	WHITE	CAPPUCHINO / CENDRE	GREY	BLACK	
STANDARD TEMPOTEST® FABRIC	NOK 2.600	PILDBB160WU	PILDBB160CAU	PILDBB160ROU	PILDBB160ZU
SYNTHETIC LEATHER STAMSKIN® WITHOUT BUTTONS	NOK 3.500	PILDBB160VCWU	PILDBB160VCCE	-	PILDBB160VCZU
SYNTHETIC LEATHER STAMSKIN® WITH BUTTONS	NOK 3.950	PILDBB160CWU	PILDBB160CCE	-	PILDBB160CZU

CUSHION DOBLEBENCH 160

0,07 m³ 3,0 kgs

DOBLE BENCH 240 CUSHION
CUSHION

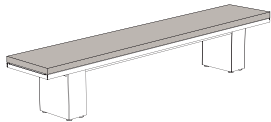

VERSION:	COLOUR:				
	WHITE	CAPPUCHINO / CENDRE	GREY	BLACK	
STANDARD TEMPOTEST® FABRIC	NOK 3.500	PILDBB240WU	PILDBB240CAU	PILDBB240ROU	PILDBB240ZU
SYNTHETIC LEATHER STAMSKIN® WITHOUT BUTTONS	NOK 5.100	PILDBB240VCWU	PILDBB240VCCE	-	PILDBB240VCZU
SYNTHETIC LEATHER STAMSKIN® WITH BUTTONS	NOK 5.500	PILDBB240CWU	PILDBB240CCE	-	PILDBB240CZU

CUSHION DOBLEBENCH 240

0,11 m³ 5,4 kgs

CUSHIONS: MATERIAL & COLOURS

TEMPOTEST®

100% SOLUTION DYED ACRYLIC FABRIC



WHITE
(WU)



CAPPUCHINO
(CAU)



GREY
(ROU)



BLACK
(ZU)

STAMSKIN®

ALL WEATHER SYNTHETIC LEATHER WITHOUT BUTTONS

STAMSKIN®
TOP



WHITE
(VCWU)



CENDRE
(VCCE)



BLACK
(VCZU)

STAMSKIN®

ALL WEATHER SYNTHETIC LEATHER WITH BUTTONS

STAMSKIN®
TOP



WHITE
(CWU)



CENDRE
(CCE)



BLACK
(CZU)

LOUNGE COLLECTION

PRODUCT

PRICES & REFERENCES

SPECS

POLTRONA LOUNGE EASY CHAIR

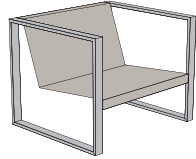

ARMREST:	BRUSHED STAINLESS STEEL	ELECTRO POLISHED STAINLESS STEEL	POWDERCOATED STAINLESS STEEL WHITE	POWDERCOATED STAINLESS STEEL CENDRE	POWDERCOATED STAINLESS STEEL BLACK	TEAK
SEAT:						
BATYLINE®						
WHITE	NOK 17.500 PTLWU	NOK 18.500 PTLEPWU	NOK 18.500 PTLWULWU	-	-	NOK 14.500 PTLTWU
CENDRE	NOK 17.500 PTLCE	NOK 18.500 PTLEPCE	-	NOK 18.500 PTLCAUCE	-	NOK 14.500 PTLTCE
BLACK	NOK 17.500 PTLZU	NOK 18.500 PTLEPZU	-	-	NOK 18.500 PTLZULZU	NOK 14.500 PTLTZU
CUSHION SET	STANDARD TEMPOTEST® FABRIC NOK 2.900		COZY TEMPOTEST® FABRIC NOK 3.500	SYNTHETIC LEATHER STAMSKIN® WITHOUT BUTTONS NOK 3.900		SYNTHETIC LEATHER STAMSKIN® WITH BUTTONS NOK 4.500

FOR MORE INFORMATION ABOUT CUSHIONS SEE PAGE 23

POLTRONA LOUNGE

M 0,57 m³ 28,5 kgs

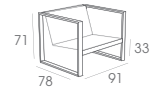

POLTRONA LOUNGE TEAK

M 0,49 m³ 25,1 kgs

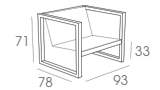

BANCA LOUNGE SOFA

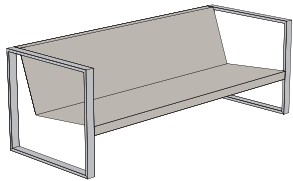

ARMREST:	BRUSHED STAINLESS STEEL	ELECTRO POLISHED STAINLESS STEEL	POWDERCOATED STAINLESS STEEL WHITE	POWDERCOATED STAINLESS STEEL CENDRE	POWDERCOATED STAINLESS STEEL BLACK	TEAK
SEAT:						
BATYLINE®						
WHITE	NOK 27.500 BCLWU	NOK 28.500 BCLEPWU	NOK 28.500 BCLWULWU	-	-	NOK 24.500 BCLTWU
CENDRE	NOK 27.500 BCLCE	NOK 28.500 BCLEPCE	-	NOK 28.500 BCLCAUCE	-	NOK 24.500 BCLTCE
BLACK	NOK 27.500 BCLZU	NOK 28.500 BCLEPZU	-	-	NOK 28.500 BCLZULZU	NOK 24.500 BCLTZU
CUSHION SET	STANDARD TEMPOTEST® FABRIC NOK 6.400		COZY TEMPOTEST® FABRIC NOK 7.600	SYNTHETIC LEATHER STAMSKIN® WITHOUT BUTTONS NOK 8.400		SYNTHETIC LEATHER STAMSKIN® WITH BUTTONS NOK 9.600

FOR MORE INFORMATION ABOUT CUSHIONS SEE PAGE 23

BANCA LOUNGE

M 1,24 m³ 39,2 kgs

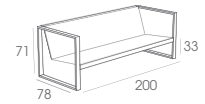

BANCA LOUNGE TEAK

M 0,69 m³ 35,8 kgs

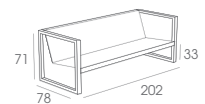

PIECERA 78 LOUNGE FOOTREST

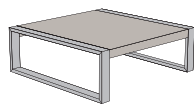

FRAME:	BRUSHED STAINLESS STEEL	ELECTRO POLISHED STAINLESS STEEL	POWDERCOATED STAINLESS STEEL WHITE	POWDERCOATED STAINLESS STEEL CENDRE	POWDERCOATED STAINLESS STEEL BLACK	TEAK
SEAT:						
BATYLINE®						
WHITE	NOK 11.500 PCL78WU	NOK 12.850 PCL78EPWU	NOK 12.850 PCL78WULWU	-	-	-
CENDRE	NOK 11.500 PCL78CE	NOK 12.850 PCL78EPCE	-	NOK 12.850 PCL78CAUCE	-	-
BLACK	NOK 11.500 PCL78ZU	NOK 12.850 PCL78EPZU	-	-	NOK 12.850 PCL78ZULZU	-
CUSHION	STANDARD TEMPOTEST® FABRIC NOK 2.400		COZY TEMPOTEST® FABRIC NOK 2.600	SYNTHETIC LEATHER STAMSKIN® WITHOUT BUTTONS NOK 3.400		SYNTHETIC LEATHER STAMSKIN® WITH BUTTONS NOK 3.600

FOR MORE INFORMATION ABOUT CUSHIONS SEE PAGE 23

PIECERA 78 LOUNGE

M 0,28 m³ 23,2 kgs

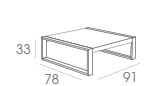

PRODUCT

PIECERA 130 LOUNGE
FOOTREST

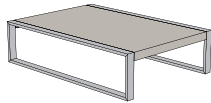

PRICES & REFERENCES

FRAME:		BRUSHED STAINLESS STEEL	ELECTRO POLISHED STAINLESS STEEL	POWDERCOATED STAINLESS STEEL WHITE	POWDERCOATED STAINLESS STEEL CENDRE	POWDERCOATED STAINLESS STEEL BLACK	TEAK
SEAT:							
BATYLINE®	WHITE	NOK 13.900 PCL130WU	NOK 14.950 PCL130EPWU	NOK 14.950 PCL130WULWU	-	-	-
	CENDRE	NOK 13.900 PCL130CE	NOK 14.950 PCL130EPCE	-	NOK 14.950 PCL130CAUCE	-	-
	BLACK	NOK 13.900 PCL130ZU	NOK 14.950 PCL130EPZU	-	-	NOK 14.950 PCL130ZULZU	-
CUSHION		STANDARD TEMPOTEST® FABRIC NOK 3.500	COZY TEMPOTEST® FABRIC NOK 4.300	SYNTHETIC LEATHER STAMSKIN® WITHOUT BUTTONS NOK 5.200	SYNTHETIC LEATHER STAMSKIN® WITH BUTTONS NOK 5.800		

FOR MORE INFORMATION ABOUT CUSHIONS SEE PAGE 23

SPECS

PIECERA 130 LOUNGE

M 0,55 m³ 33,0 kgs

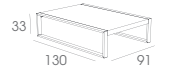

SIESTA LOUNGE
SUNLOUNGER

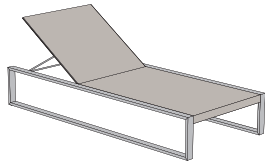

FRAME:		BRUSHED STAINLESS STEEL	ELECTRO POLISHED STAINLESS STEEL	POWDERCOATED STAINLESS STEEL WHITE	POWDERCOATED STAINLESS STEEL CENDRE	POWDERCOATED STAINLESS STEEL BLACK	TEAK
SEAT:							
BATYLINE®	WHITE	NOK 18.950 STLWU	NOK 22.400 STLEPWU	NOK 22.400 STLWULWU	-	-	-
	CENDRE	NOK 18.950 STLCE	NOK 22.400 STLEPCE	-	NOK 22.400 STLCAUCE	-	-
	BLACK	NOK 18.950 STLZU	NOK 22.400 STLEPZU	-	-	NOK 22.400 STLZULZU	-
CUSHION		STANDARD TEMPOTEST® FABRIC NOK 6.300	SYNTHETIC LEATHER STAMSKIN® WITHOUT BUTTONS NOK 8.200	SYNTHETIC LEATHER STAMSKIN® WITH BUTTONS NOK 8.800			

FOR MORE INFORMATION ABOUT CUSHIONS SEE PAGE 23

SIESTA LOUNGE

M 0,77 m³ 56,0 kgs

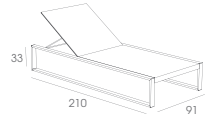

SIESTA LOUNGE TWIN
SUNLOUNGER

- EXTRA LEAD TIME

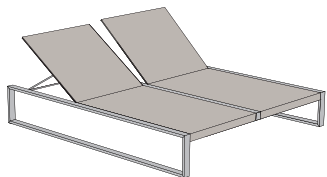

FRAME:		BRUSHED STAINLESS STEEL	ELECTRO POLISHED STAINLESS STEEL	POWDERCOATED STAINLESS STEEL WHITE	POWDERCOATED STAINLESS STEEL CENDRE	POWDERCOATED STAINLESS STEEL BLACK	TEAK
SEAT:							
BATYLINE®	WHITE	NOK 39.000 STL2WU	NOK 41.000 STL2EPWU	NOK 41.000 STL2WULWU	-	-	-
	CENDRE	NOK 39.000 STL2CE	NOK 41.000 STL2EPCE	-	NOK 41.000 STL2CAUCE	-	-
	BLACK	NOK 39.000 STL2ZU	NOK 41.000 STL2EPZU	-	-	NOK 41.000 STL2ZULZU	-
CUSHION		STANDARD TEMPOTEST® FABRIC NOK 12.600	SYNTHETIC LEATHER STAMSKIN® WITHOUT BUTTONS NOK 16.400	SYNTHETIC LEATHER STAMSKIN® WITH BUTTONS NOK 17.600	2x SIESTA LOUNGE CUSHION		

FOR MORE INFORMATION ABOUT CUSHIONS SEE PAGE 23

SIESTA LOUNGE TWIN

M 1,55 m³ 92,9 kgs

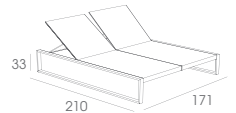

PRODUCT

PRICES & REFERENCES

SPECS

TABLA 150 LOUNGE
LOW TABLE

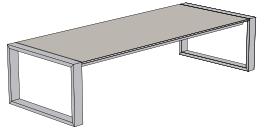

TOP:	BASE:	BRUSHED STAINLESS STEEL	ELECTRO POLISHED STAINLESS STEEL	POWDERCOATED STAINLESS STEEL WHITE	POWDERCOATED STAINLESS STEEL CENDRE	POWDERCOATED STAINLESS STEEL BLACK	TEAK
GLASS 10 mm	WHITE	NOK 11.900 TLL150GWU	NOK 12.900 TLL150GEPWU	NOK 12.900 TLL150GWULWU	NOK 12.900 TLL150GCAUWU	NOK 12.900 TLL150GZULWU	NOK 11.900 TLL150GTWU
	CENDRE	NOK 11.900 TLL150GCLU	NOK 12.900 TLL150GEPCLU	NOK 12.900 TLL150GWULCLU	NOK 12.900 TLL150GCAUCLU	NOK 12.900 TLL150GZULCLU	NOK 11.900 TLL150GTCLU
	BLACK	NOK 11.900 TLL150GZU	NOK 12.900 TLL150GEPZU	NOK 12.900 TLL150GWULZU	NOK 12.900 TLL150GCAUZU	NOK 12.900 TLL150GZULZU	NOK 11.900 TLL150GTZU
CERAMIC 10 mm	WHITE	NOK 13.200 TLL150CWU	NOK 14.300 TLL150CEPWU	NOK 14.300 TLL150CWULWU	NOK 14.300 TLL150CCAUWU	NOK 14.300 TLL150CZULWU	NOK 13.200 TLL150CTWU
	CENDRE	NOK 13.200 TLL150CCLU	NOK 14.300 TLL150CEPCLU	NOK 14.300 TLL150CWULCLU	NOK 14.300 TLL150CCAUCLU	NOK 14.300 TLL150CZULCLU	NOK 13.200 TLL150CTCLU
	BLACK	NOK 13.200 TLL150CZU	NOK 14.300 TLL150CEPZU	NOK 14.300 TLL150CWULZU	NOK 14.300 TLL150CCAUZU	NOK 14.300 TLL150CZULZU	NOK 13.200 TLL150CTZU
TEAK 20 mm	TEAK	NOK 11.900 TLL150T	NOK 12.900 TLL150TEP	NOK 12.900 TLL150TWUL	NOK 12.900 TLL150TCAU	NOK 12.900 TLL150TZUL	NOK 11.900 TLL150TT

TABLA 150 LOUNGE
GLASS 0,41 m³ 35,2 kgs
CERAMIC 0,41 m³ 35,2 kgs
TEAK 0,41 m³ 32,8 kgs



TABLA 150 LOUNGE TEAK
GLASS 0,11 m³ 33,8 kgs
CERAMIC 0,11 m³ 33,8 kgs
TEAK 0,11 m³ 31,0 kgs



TABLA 200 LOUNGE
LOW TABLE

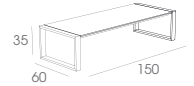

TOP:	BASE:	BRUSHED STAINLESS STEEL	ELECTRO POLISHED STAINLESS STEEL	POWDERCOATED STAINLESS STEEL WHITE	POWDERCOATED STAINLESS STEEL CENDRE	POWDERCOATED STAINLESS STEEL BLACK	TEAK
GLASS 10 mm	WHITE	NOK 13.900 TLL200GWU	NOK 14.900 TLL200GEPWU	NOK 14.900 TLL200GWULWU	NOK 14.900 TLL200GCAUWU	NOK 14.900 TLL200GZULWU	NOK 13.900 TLL200GTWU
	CENDRE	NOK 13.900 TLL200GCLU	NOK 14.900 TLL200GEPCLU	NOK 14.900 TLL200GWULCLU	NOK 14.900 TLL200GCAUCLU	NOK 14.900 TLL200GZULCLU	NOK 13.900 TLL200GTCLU
	BLACK	NOK 13.900 TLL200GZU	NOK 14.900 TLL200GEPZU	NOK 14.900 TLL200GWULZU	NOK 14.900 TLL200GCAUZU	NOK 14.900 TLL200GZULZU	NOK 13.900 TLL200GTZU
CERAMIC 10 mm	WHITE	NOK 15.400 TLL200CWU	NOK 16.500 TLL200CEPWU	NOK 16.500 TLL200CWULWU	NOK 16.500 TLL200CCAUWU	NOK 16.500 TLL200CZULWU	NOK 15.400 TLL200CTWU
	CENDRE	NOK 15.400 TLL200CCLU	NOK 16.500 TLL200CEPCLU	NOK 16.500 TLL200CWULCLU	NOK 16.500 TLL200CCAUCLU	NOK 16.500 TLL200CZULCLU	NOK 15.400 TLL200CTCLU
	BLACK	NOK 15.400 TLL200CZU	NOK 16.500 TLL200CEPZU	NOK 16.500 TLL200CWULZU	NOK 16.500 TLL200CCAUZU	NOK 16.500 TLL200CZULZU	NOK 15.400 TLL200CTZU
TEAK 20 mm	TEAK	NOK 13.900 TLL200T	NOK 14.900 TLL200TEP	NOK 14.900 TLL200TWUL	NOK 14.900 TLL200TCAU	NOK 14.900 TLL200TZUL	NOK 13.900 TLL200TT

TABLA 200 LOUNGE
GLASS 0,57 m³ 38,2 kgs
CERAMIC 0,57 m³ 38,2 kgs
TEAK 0,57 m³ 35,8 kgs

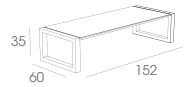
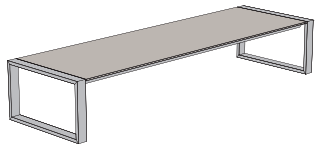

TABLA 200 LOUNGE TEAK
GLASS 0,13 m³ 36,8 kgs
CERAMIC 0,13 m³ 36,8 kgs
TEAK 0,13 m³ 34,4 kgs



PRODUCT

MESITA 45 LOUNGE
SIDE TABLE

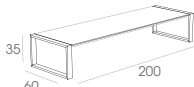
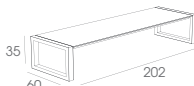
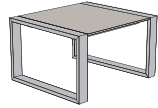

PRICES & REFERENCES

TOP:	BASE:	BRUSHED STAINLESS STEEL	ELECTRO POLISHED STAINLESS STEEL	POWDERCOATED STAINLESS STEEL WHITE	POWDERCOATED STAINLESS STEEL CENDRE	POWDERCOATED STAINLESS STEEL BLACK	TEAK
GLASS 10 mm	WHITE	NOK 59.500 MSL45GWU	NOK 64.500 MSL45GEPWU	NOK 64.500 MSL45GWULWU	NOK 64.500 MSL45GCAUWU	NOK 64.500 MSL45GZULWU	NOK 59.500 MSL45GTWU
	CENDRE	NOK 59.500 MSL45GCLU	NOK 64.500 MSL45GEPCLU	NOK 64.500 MSL45GWULCLU	NOK 64.500 MSL45GCAUCLU	NOK 64.500 MSL45GZULCLU	NOK 59.500 MSL45GTCLU
	BLACK	NOK 59.500 MSL45GZU	NOK 64.500 MSL45GEPZU	NOK 64.500 MSL45GWULZU	NOK 64.500 MSL45GCAUZU	NOK 64.500 MSL45GZULZU	NOK 59.500 MSL45GTZU
CERAMIC 10 mm	WHITE	NOK 65.500 MSL45CWU	NOK 71.000 MSL45CEPWU	NOK 71.000 MSL45CWULWU	NOK 71.000 MSL45CCAUWU	NOK 71.000 MSL45CZULWU	NOK 65.500 MSL45CTWU
	CENDRE	NOK 65.500 MSL45CCLU	NOK 71.000 MSL45CEPCLU	NOK 71.000 MSL45CWULCLU	NOK 71.000 MSL45CCAUCLU	NOK 71.000 MSL45CZULCLU	NOK 65.500 MSL45CTCLU
	BLACK	NOK 65.500 MSL45CZU	NOK 71.000 MSL45CEPZU	NOK 71.000 MSL45CWULZU	NOK 71.000 MSL45CCAUZU	NOK 71.000 MSL45CZULZU	NOK 65.500 MSL45CTZU
TEAK 20 mm	TEAK	NOK 59.500 MSL45T	NOK 64.500 MSL45TEP	NOK 64.500 MSL45TWUL	NOK 64.500 MSL45TCAU	NOK 64.500 MSL45TZUL	NOK 59.500 MSL45TT

SPECS

MESITA 45 LOUNGE

GLASS	0,12 m³	14,6 kgs
CERAMIC	0,12 m³	14,6 kgs
TEAK	0,12 m³	13,5 kgs

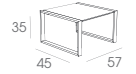

MESITA 45 LOUNGE TEAK

GLASS	0,03 m³	13,6 kgs
CERAMIC	0,03 m³	13,6 kgs
TEAK	0,03 m³	12,5 kgs

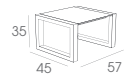

MESITA 78 LOUNGE
LOW TABLE

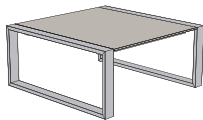

TOP:	BASE:	BRUSHED STAINLESS STEEL	ELECTRO POLISHED STAINLESS STEEL	POWDERCOATED STAINLESS STEEL WHITE	POWDERCOATED STAINLESS STEEL CENDRE	POWDERCOATED STAINLESS STEEL BLACK	TEAK
GLASS 10 mm	WHITE	NOK 9.950 MSL78GWU	NOK 11.300 MSL78GEPWU	NOK 11.300 MSL78GWULWU	NOK 11.300 MSL78GCAUWU	NOK 11.300 MSL78GZULWU	NOK 9.950 MSL78GTWU
	CENDRE	NOK 9.950 MSL78GCLU	NOK 11.300 MSL78GEPCLU	NOK 11.300 MSL78GWULCLU	NOK 11.300 MSL78GCAUCLU	NOK 11.300 MSL78GZULCLU	NOK 9.950 MSL78GTCLU
	BLACK	NOK 9.950 MSL78GZU	NOK 11.300 MSL78GEPZU	NOK 11.300 MSL78GWULZU	NOK 11.300 MSL78GCAUZU	NOK 11.300 MSL78GZULZU	NOK 9.950 MSL78GTZU
CERAMIC 10 mm	WHITE	NOK 10.950 MSL78CWU	NOK 12.450 MSL78CEPWU	NOK 12.450 MSL78CWULWU	NOK 12.450 MSL78CCAUWU	NOK 12.450 MSL78CZULWU	NOK 10.950 MSL78CTWU
	CENDRE	NOK 10.950 MSL78CCLU	NOK 12.450 MSL78CEPCLU	NOK 12.450 MSL78CWULCLU	NOK 12.450 MSL78CCAUCLU	NOK 12.450 MSL78CZULCLU	NOK 10.950 MSL78CTCLU
	BLACK	NOK 10.950 MSL78CZU	NOK 12.450 MSL78CEPZU	NOK 12.450 MSL78CWULZU	NOK 12.450 MSL78CCAUZU	NOK 12.450 MSL78CZULZU	NOK 10.950 MSL78CTZU
TEAK 20 mm	TEAK	NOK 9.950 MSL78T	NOK 11.300 MSL78TEP	NOK 11.300 MSL78TWUL	NOK 11.300 MSL78TCAU	NOK 11.300 MSL78TZUL	NOK 9.950 MSL78TT

MESITA 78 LOUNGE

GLASS	0,23 m³	27,2 kgs
CERAMIC	0,23 m³	27,2 kgs
TEAK	0,23 m³	25,4 kgs

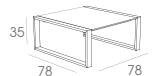

MESITA 78 LOUNGE TEAK

GLASS	0,14 m³	25,0 kgs
CERAMIC	0,14 m³	25,0 kgs
TEAK	0,14 m³	23,8 kgs

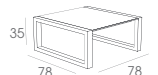

PRODUCT

MESITA 91 LOUNGE
LOW TABLE

PRICES & REFERENCES

SPECS

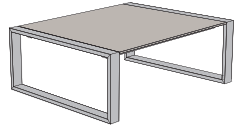

TOP:	BASE:	BRUSHED STAINLESS STEEL	ELECTRO POLISHED STAINLESS STEEL	POWDERCOATED STAINLESS STEEL WHITE	POWDERCOATED STAINLESS STEEL CENDRE	POWDERCOATED STAINLESS STEEL BLACK	TEAK
GLASS 10 mm	WHITE	NOK 10.950 MSL91GWU	NOK 12.200 MSL91GEPWU	NOK 12.200 MSL91GWULWU	NOK 12.200 MSL91GCAUWU	NOK 12.200 MSL91GZULWU	NOK 11.500 MSL91GTWU
	CENDRE	NOK 10.950 MSL91GCLU	NOK 12.200 MSL91GEPCLU	NOK 12.200 MSL91GWULCLU	NOK 12.200 MSL91GCAUCLU	NOK 12.200 MSL91GZULCLU	NOK 11.500 MSL91GTCLU
	BLACK	NOK 10.950 MSL91GZU	NOK 12.200 MSL91GEPZU	NOK 12.200 MSL91GWULZU	NOK 12.200 MSL91GCAUZU	NOK 12.200 MSL91GZULZU	NOK 11.500 MSL91GTZU
CERAMIC 10 mm	WHITE	NOK 12.200 MSL91CWU	NOK 13.450 MSL91CEPWU	NOK 13.450 MSL91CWULWU	NOK 13.450 MSL91CCAUWU	NOK 13.450 MSL91CZULWU	NOK 12.650 MSL91CTWU
	CENDRE	NOK 12.200 MSL91CCLU	NOK 13.450 MSL91CEPCLU	NOK 13.450 MSL91CWULCLU	NOK 13.450 MSL91CCAUCLU	NOK 13.450 MSL91CZULCLU	NOK 12.650 MSL91CTCLU
	BLACK	NOK 12.200 MSL91CZU	NOK 13.450 MSL91CEPZU	NOK 13.450 MSL91CWULZU	NOK 13.450 MSL91CCAUZU	NOK 13.450 MSL91CZULZU	NOK 12.650 MSL91CTZU
TEAK 20 mm	TEAK	NOK 10.950 MSL91T	NOK 12.200 MSL91TEP	NOK 12.200 MSL91TWUL	NOK 12.200 MSL91TCAU	NOK 12.200 MSL91TZUL	NOK 10.950 MSL91TT

MESITA 91 LOUNGE
GLASS 0,29 m³ 29,4 kgs
CERAMIC 0,29 m³ 29,4 kgs
TEAK 0,29 m³ 27,1 kgs

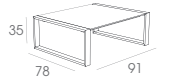

MESITA 91 LOUNGE TEAK
GLASS 0,16 m³ 27,4 kgs
CERAMIC 0,16 m³ 27,4 kgs
TEAK 0,16 m³ 24,9 kgs



MODULAR SYSTEM PARTS

PRODUCT

ESQUINA LOUNGE
MODULAR CORNER SEAT
(NO CONNECTOR NEEDED)

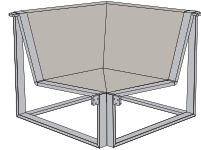

PRICES & REFERENCES

SEAT:	FRAME:	BRUSHED STAINLESS STEEL	ELECTRO POLISHED STAINLESS STEEL	POWDERCOATED STAINLESS STEEL WHITE	POWDERCOATED STAINLESS STEEL CENDRE	POWDERCOATED STAINLESS STEEL BLACK	TEAK
BATYLINE®							
WHITE		NOK 15.900 ESQWU	NOK 18.500 ESQEPWU	NOK 18.500 ESQWULWU	-	-	-
CENDRE		NOK 15.900 ESQCE	NOK 18.500 ESQEPCE	-	NOK 18.500 ESQCAUCE	-	-
BLACK		NOK 15.900 ESQZU	NOK 18.500 ESQEPZU	-	-	NOK 18.500 ESQZULZU	-
CUSHION SET		STANDARD TEMPOTEST® FABRIC NOK 5.000	COZY TEMPOTEST® FABRIC NOK 5.800	SYNTHETIC LEATHER STAMSKIN® WITHOUT BUTTONS NOK 6.300	SYNTHETIC LEATHER STAMSKIN® WITH BUTTONS NOK 6.800		

FOR MORE INFORMATION ABOUT CUSHIONS SEE PAGE 23

SPECS

ESQUINA LOUNGE

M³ 0,57 m³ P 28,5 kgs

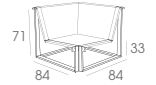

POLTRONA LOUNGE SEAT
MODULAR SINGLE SEAT

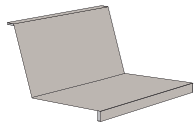

SEAT:	FRAME:	STAINLESS STEEL EP
BATYLINE®		
WHITE		NOK 9.800 PTLSEATEPWU
CENDRE		NOK 9.800 PTLSEATEPCE
BLACK		NOK 9.800 PTLSEATEPZU
CUSHION SET	FOR MORE INFORMATION ABOUT CUSHIONS FOR THE MODULAR SYSTEM SEE PAGE 23	

BANCA LOUNGE SEAT
MODULAR DOUBLE SEAT

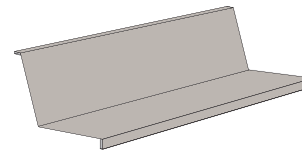

SEAT:	FRAME:	STAINLESS STEEL EP
BATYLINE®		
WHITE		NOK 19.800 BCLSEATEPWU
CENDRE		NOK 19.800 BCLSEATEPCE
BLACK		NOK 19.800 BCLSEATEPZU
CUSHION SET	FOR MORE INFORMATION ABOUT CUSHIONS FOR THE MODULAR SYSTEM SEE PAGE 23	

POLTRONA LOUNGE SEAT

M³ 0,31 m³ P 11,7 kgs

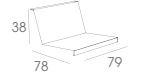

BANCA LOUNGE SEAT

M³ 0,51 m³ P 22,4 kgs

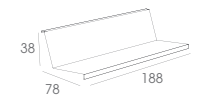

HOW TO USE AN ESQUINA LOUNGE & MODULAR SEATS:

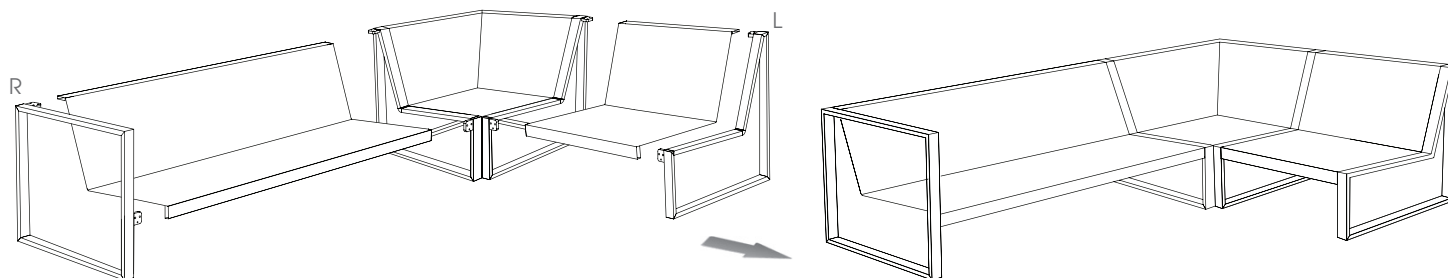

MODULAR SYSTEM PARTS

PRODUCT

ARMRESTS
MODULAR ARMREST
LEFT OR RIGHT (WHEN SEATED)

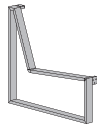
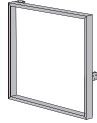

PRICES & REFERENCES

FRAME:		BRUSHED STAINLESS STEEL	ELECTRO POLISHED STAINLESS STEEL	POWDERCOATED STAINLESS STEEL WHITE	POWDERCOATED STAINLESS STEEL CENDRE	POWDERCOATED STAINLESS STEEL BLACK	TEAK
ARMREST HIGH	LEFT:	NOK 3.850 CNHL	NOK 4.350 CNHLEP	NOK 4.350 CNHLWUL	NOK 4.350 CNHLCAU	NOK 4.350 CNHLZUL	NOK 2.350 CNHLT
	RIGHT:	NOK 3.850 CNHR	NOK 4.350 CNHREP	NOK 4.350 CNHRWUL	NOK 4.350 CNHRCAU	NOK 4.350 CNHRZUL	NOK 2.350 CNHRT
ARMREST LOW	LEFT:	NOK 3.800 CNL	NOK 4.300 CNLEP	NOK 4.300 CNLWUL	NOK 4.300 CNLCAU	NOK 4.300 CNLZUL	-
	RIGHT:	NOK 3.800 CNR	NOK 4.300 CNREP	NOK 4.300 CNRWUL	NOK 4.300 CNRCAU	NOK 4.300 CNRZUL	-

SPECS

ARMREST HIGH

SS 0,08 m³ 8,9 kgs

TEAK 0,09 m³ 6,7 kgs

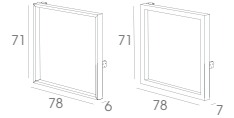

ARMREST LOW

0,08 m³ 8,8 kgs

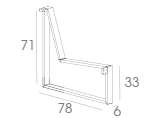

CONNECTOR
MODULAR SEAT CONNECTOR

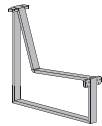

FRAME:		BRUSHED STAINLESS STEEL	ELECTRO POLISHED STAINLESS STEEL	POWDERCOATED STAINLESS STEEL WHITE	POWDERCOATED STAINLESS STEEL CENDRE	POWDERCOATED STAINLESS STEEL BLACK	TEAK
CONNECTOR		NOK 4.700 CNC	NOK 5.200 CNCEP	NOK 5.200 CNCWUL	NOK 5.200 CNCCAU	NOK 5.200 CNCZUL	-

CONNECTOR

0,09 m³ 8,9 kgs

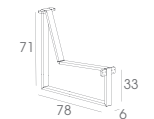

HOW TO USE AN LOUNGE CONNECTOR:

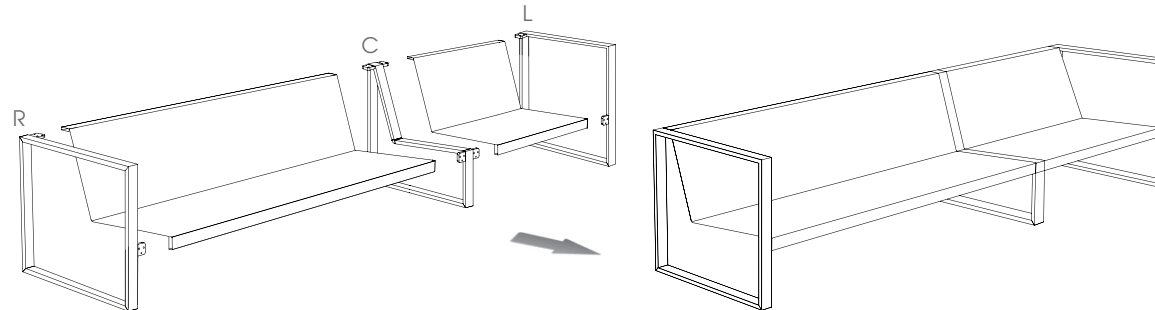

STANDARD ARRANGEMENTS OF MODULAR LOUNGE SETS

ARRANGEMENT 1
MODULAR LOUNGE SET

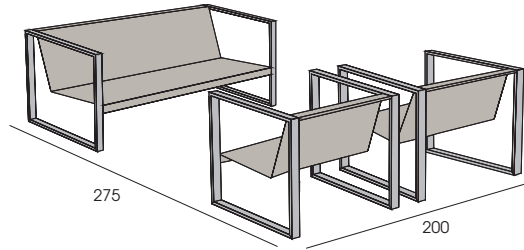

SET PRICE WITH CUSHIONS
PRICE IS BASED ON STAINLESS STEEL FRAME - BRUSHED VERSION

STANDARD	NOK 74.700
COZY	NOK 77.100
SYNTHETIC LEATHER WITHOUT BUTTONS	NOK 78.700
SYNTHETIC LEATHER WITH BUTTONS	NOK 81.100

ARRANGEMENT 4
MODULAR LOUNGE SET

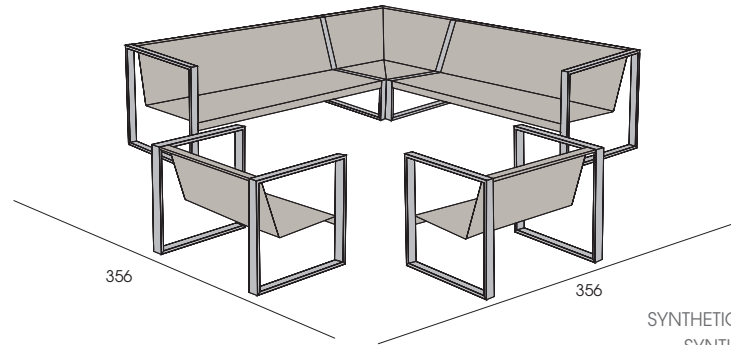

SET PRICE WITH CUSHIONS
PRICE IS BASED ON STAINLESS STEEL FRAME - BRUSHED VERSION

STANDARD	NOK 122.400
COZY	NOK 126.800
SYNTHETIC LEATHER WITHOUT BUTTONS	NOK 129.700
SYNTHETIC LEATHER WITH BUTTONS	NOK 133.800

ARRANGEMENT 2
MODULAR LOUNGE SET

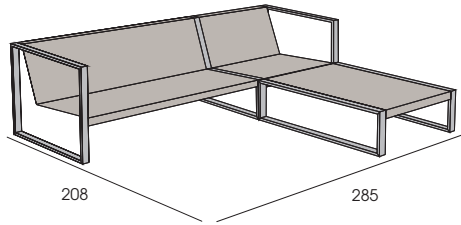

SET PRICE WITH CUSHIONS
PRICE IS BASED ON STAINLESS STEEL FRAME - BRUSHED VERSION

STANDARD	NOK 69.000
COZY	NOK 71.600
SYNTHETIC LEATHER WITHOUT BUTTONS	NOK 73.700
SYNTHETIC LEATHER WITH BUTTONS	NOK 76.100

ARRANGEMENT 5
MODULAR LOUNGE SET

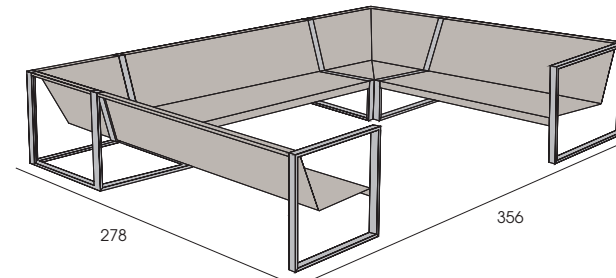

SET PRICE WITH CUSHIONS
PRICE IS BASED ON STAINLESS STEEL FRAME - BRUSHED VERSION

STANDARD	NOK 129.300
COZY	NOK 134.500
SYNTHETIC LEATHER WITHOUT BUTTONS	NOK 137.900
SYNTHETIC LEATHER WITH BUTTONS	NOK 142.250

ARRANGEMENT 3
MODULAR LOUNGE SET

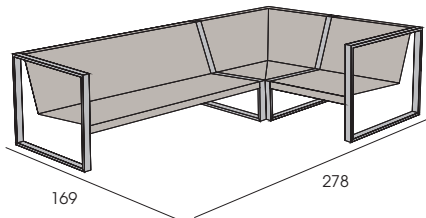

SET PRICE WITH CUSHIONS
PRICE IS BASED ON STAINLESS STEEL FRAME - BRUSHED VERSION

STANDARD	NOK 68.000
COZY	NOK 70.600
SYNTHETIC LEATHER WITHOUT BUTTONS	NOK 72.300
SYNTHETIC LEATHER WITH BUTTONS	NOK 74.600

ARRANGEMENT 6
MODULAR LOUNGE SET

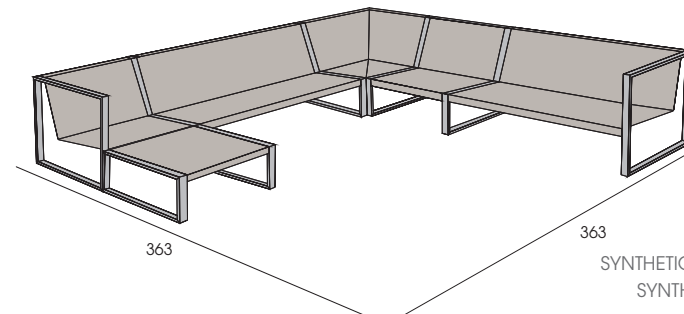

SET PRICE WITH CUSHIONS
PRICE IS BASED ON STAINLESS STEEL FRAME - BRUSHED VERSION

STANDARD	NOK 121.300
COZY	NOK 125.900
SYNTHETIC LEATHER WITHOUT BUTTONS	NOK 129.600
SYNTHETIC LEATHER WITH BUTTONS	NOK 133.650

CUSHIONS LOUNGE COLLECTION

WHEN TO USE THE EXTRA LARGE CUSHIONS FOR THE POLTRONA & BANCA LOUNGE

DIFFERENT SIZED CUSHIONS ARE AVAILABLE FOR THE POLTRONA LOUNGE AND BANCA LOUNGE. THE REGULAR SIZE IS TO BE USED IN THE REGULAR SETTING WITH ARMREST. THE XL AND XXL CUSHIONS EXTEND OVER THE CONNECTOR OR THE FRAME OF THE ESQUINA LOUNGE (SEE PICTURE BELOW). THE XL CUSHIONS ARE TO BE USED IN CASE OF A MODULAR COMBINATION OF ONE POLTRONA LOUNGE OR BANCA LOUNGE WITH A CONNECTOR OR ESQUINA LOUNGE. THE XXL POLTRONA LOUNGE AND BANCA LOUNGE CUSHION IS TO BE USED IF THE BANCA LOUNGE SEAT IS EXTENDED ON BOTH SIDES BY A CONNECTOR OR ESQUINA LOUNGE.

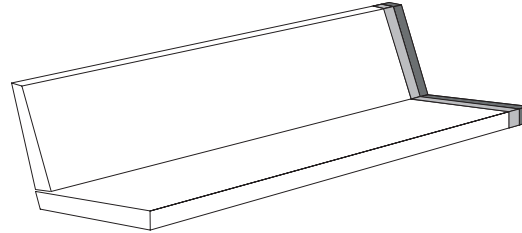
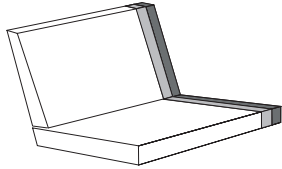

- CUSHION POLTRONA LOUNGE - REGULAR SIZE
- CUSHION POLTRONA LOUNGE - XL (+6 cm)
- CUSHION POLTRONA LOUNGE - XXL (+12 cm)

- CUSHION BANCA LOUNGE - REGULAR SIZE
- CUSHION BANCA LOUNGE - XL (+6 cm)
- CUSHION BANCA LOUNGE - XXL (+12 cm)

REGULAR SIZE CUSHION

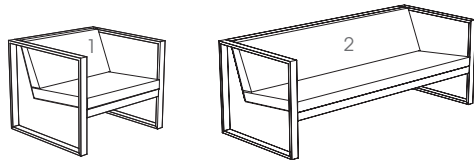

XL CUSHION

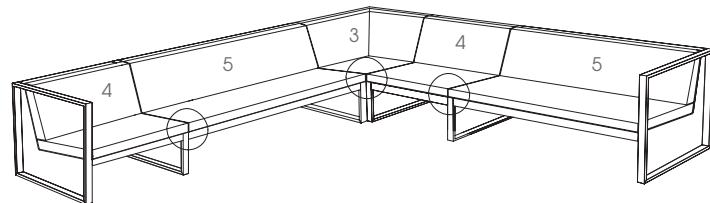
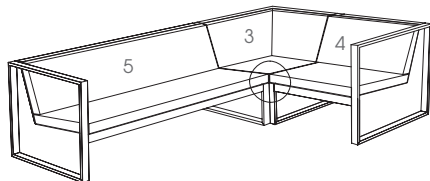
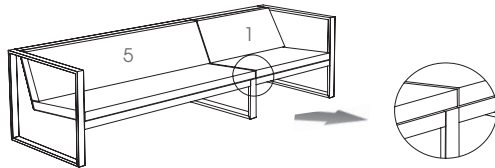

PRODUCTS: REFERENCE:

- | | | | |
|---|--|-----------------------------|-------------|
| 1 | | POLTRONA LOUNGE CUSHION | PIL-PTL- |
| 2 | | BANCA LOUNGE CUSHION | PIL-BCL- |
| 3 | | ESQUINA LOUNGE CUSHION | PIL-ESQ- |
| 4 | | XL POLTRONA LOUNGE CUSHION | PIL-XLPTL- |
| 5 | | XL BANCA LOUNGE CUSHION | PIL-XLBCL- |
| 6 | | XXL POLTRONA LOUNGE CUSHION | PIL-XXLPTL- |
| 7 | | XXL BANCA LOUNGE CUSHION | PIL-XXLBCL- |

XXL CUSHION

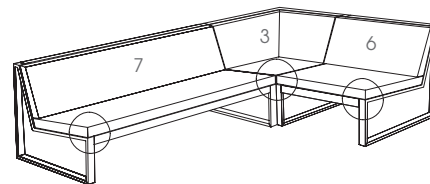

CUSHION VERSIONS

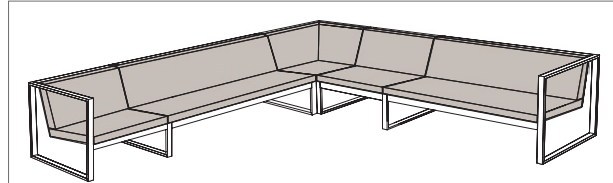

- STANDARD
- TEMPOTEST® 100% SOLUTION DYED ACRYLIC FABRIC
- WHITE (WU)
 - GREY (ROU)
 - CAPPUCHINO (CAU)
 - BLACK (ZU)

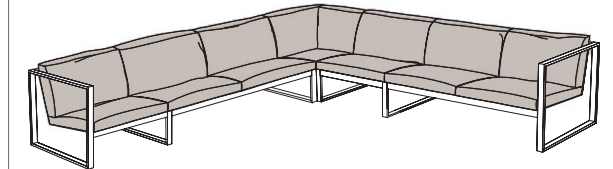

- COZY
- TEMPOTEST® 100% SOLUTION DYED ACRYLIC FABRIC
- WHITE (YUW)
 - GREY (YRU)
 - CAPPUCHINO (YCAU)
 - BLACK (YU)

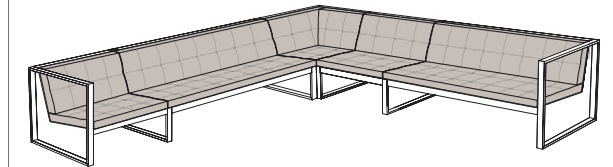

- SYNTHETIC LEATHER WITH BUTTONS
- STAMSKIN® ALL WEATHER SYNTHETIC LEATHER
- STAMSKIN® TOP
- WHITE (CWU)
 - CENDRE (CCE)
 - BLACK (CZU)

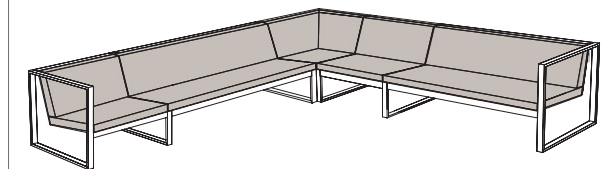

- SYNTHETIC LEATHER WITHOUT BUTTONS
- STAMSKIN® ALL WEATHER SYNTHETIC LEATHER
- STAMSKIN® TOP
- WHITE (VCWU)
 - CENDRE (VCCE)
 - BLACK (VCZU)

PRODUCT

PRICES & REFERENCES

SPECS

ESQUINA LOUNGE CUSHION SET

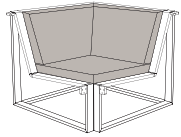

VERSION:	COLOUR:	WHITE	CAPPUCHINO / CENDRE	GREY	BLACK
STANDARD TEMPOTEST® FABRIC	NOK 5.000	PIESQWU	PIESQCAU	PIESQROU	PIESQZU
COZY TEMPOTEST® FABRIC	NOK 5.800	PIESQYWU	PIESQYCAU	PIESQYROU	PIESQYZU
SYNTHETIC LEATHER STAMSKIN® WITHOUT BUTTONS	NOK 6.300	PIESQVCWU	PIESQVCCE	-	PIESQVCZU
SYNTHETIC LEATHER STAMSKIN® WITH BUTTONS	NOK 6.800	PIESQCWU	PIESQCCE	-	PIESQCZU

CUSHION ESQUINA LOUNGE

M³ 0,10 m³ K^G 5,8 kgs

POLTRONA LOUNGE CUSHION SET

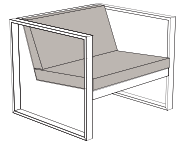

VERSION:	COLOUR:	WHITE	CAPPUCHINO / CENDRE	GREY	BLACK
STANDARD TEMPOTEST® FABRIC	NOK 2.900	PILPTLWU	PILPTLCAU	PILPTLROU	PILPTLZU
COZY TEMPOTEST® FABRIC	NOK 3.500	PILPTLYWU	PILPTLYCAU	PILPTLYROU	PILPTLYZU
SYNTHETIC LEATHER STAMSKIN® WITHOUT BUTTONS	NOK 3.900	PILPTLVCWU	PILPTLVCCE	-	PILPTLVCZU
SYNTHETIC LEATHER STAMSKIN® WITH BUTTONS	NOK 4.500	PILPTLCWU	PILPTLCCE	-	PILPTLCZU

CUSHION POLTRONA LOUNGE

M³ 0,09 m³ K^G 3,8 kgs

XL POLTRONA LOUNGE CUSHION SET

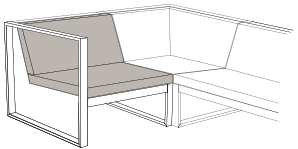

VERSION:	COLOUR:	WHITE	CAPPUCHINO / CENDRE	GREY	BLACK
STANDARD TEMPOTEST® FABRIC	NOK 3.100	PILXLPTLWU	PILXLPTLCAU	PILXLPTLROU	PILXLPTLZU
COZY TEMPOTEST® FABRIC	NOK 3.700	PILXLPTLYWU	PILXLPTLYCAU	PILXLPTLYROU	PILXLPTLYZU
SYNTHETIC LEATHER STAMSKIN® WITHOUT BUTTONS	NOK 4.100	PILXLPTLVCWU	PILXLPTLVCCE	-	PILXLPTLVCZU
SYNTHETIC LEATHER STAMSKIN® WITH BUTTONS	NOK 4.700	PILXLPTLCWU	PILXLPTLCCE	-	PILXLPTLCZU

XL CUSHION POLTRONA LOUNGE

M³ 0,10 m³ K^G 4,0 kgs

XXL POLTRONA LOUNGE CUSHION SET

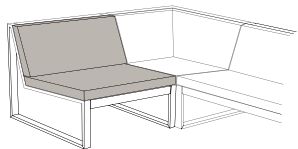

VERSION:	COLOUR:	WHITE	CAPPUCHINO / CENDRE	GREY	BLACK
STANDARD TEMPOTEST® FABRIC	NOK 3.300	PILXXLPTLWU	PILXXLPTLCAU	PILXXLPTLROU	PILXXLPTLZU
COZY TEMPOTEST® FABRIC	NOK 3.900	PILXXLPTLYWU	PILXXLPTLYCAU	PILXXLPTLYROU	PILXXLPTLYZU
SYNTHETIC LEATHER STAMSKIN® WITHOUT BUTTONS	NOK 4.300	PILXXLPTLVCWU	PILXXLPTLVCCE	-	PILXXLPTLVCZU
SYNTHETIC LEATHER STAMSKIN® WITH BUTTONS	NOK 4.900	PILXXLPTLCWU	PILXXLPTLCCE	-	PILXXLPTLCZU

XXL CUSHION POLTRONA LOUNGE

M³ 0,11 m³ K^G 4,2 kgs

CUSHIONS: MATERIAL & COLOURS

TEMPOTEST®
100% SOLUTION DYED ACRYLIC FABRIC



WHITE
(WU)

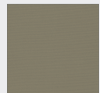

CAPPUCHINO
(CAU)



GREY
(ROU)



BLACK
(ZU)

STAMSKIN®
ALL WEATHER SYNTHETIC LEATHER WITHOUT BUTTONS

STAMSKIN®
TOP



WHITE
(VCWU)

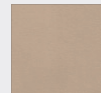

CENDRE
(VCCE)



BLACK
(VCZU)

STAMSKIN®
ALL WEATHER SYNTHETIC LEATHER WITH BUTTONS

STAMSKIN®
TOP

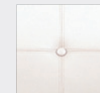

WHITE
(CWU)

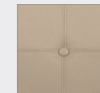

CENDRE
(CCE)



BLACK
(CZU)

PRODUCT

PRICES & REFERENCES

SPECS

BANCA LOUNGE CUSHION SET

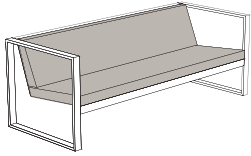

VERSION:	COLOUR:	WHITE	CAPPUCHINO / CENDRE	GREY	BLACK
STANDARD TEMPOTEST® FABRIC	NOK 6.400	PILBCLWU	PILBCLCAU	PILBCLROU	PILBCLZU
COZY TEMPOTEST® FABRIC	NOK 7.600	PILBCLYWU	PILBCLYCAU	PILBCLYROU	PILBCLYZU
SYNTHETIC LEATHER STAMSKIN® WITHOUT BUTTONS	NOK 8.400	PILBCLVCWU	PILBCLVCCE	-	PILBCLVCZU
SYNTHETIC LEATHER STAMSKIN® WITH BUTTONS	NOK 9.600	PILBCLCWU	PILBCLCCE	-	PILBCLCZU

CUSHION BANCA LOUNGE

M³ 0,21 m³ K^G 7,8 kgs

XL BANCA LOUNGE CUSHION SET

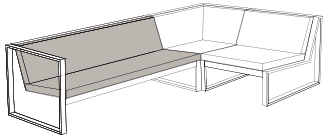

VERSION:	COLOUR:	WHITE	CAPPUCHINO / CENDRE	GREY	BLACK
STANDARD TEMPOTEST® FABRIC	NOK 6.900	PILXLBCLWU	PILXLBCLCAU	PILXLBCLROU	PILXLBCLZU
COZY TEMPOTEST® FABRIC	NOK 7.900	PILXLBCLYWU	PILXLBCLYCAU	PILXLBCLYROU	PILXLBCLYZU
SYNTHETIC LEATHER STAMSKIN® WITHOUT BUTTONS	NOK 8.700	PILXLBCLVCWU	PILXLBCLVCCE	-	PILXLBCLVCZU
SYNTHETIC LEATHER STAMSKIN® WITH BUTTONS	NOK 9.900	PILXLBCLCWU	PILXLBCLCCE	-	PILXLBCLCZU

XL CUSHION BANCA LOUNGE

M³ 0,22 m³ K^G 8,0 kgs

XXL BANCA LOUNGE CUSHION SET

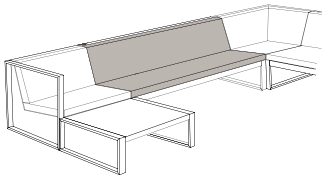

VERSION:	COLOUR:	WHITE	CAPPUCHINO / CENDRE	GREY	BLACK
STANDARD TEMPOTEST® FABRIC	NOK 7.000	PILXXLBCLWU	PILXXLBCLCAU	PILXXLBCLROU	PILXXLBCLZU
COZY TEMPOTEST® FABRIC	NOK 8.200	PILXXLBCLYWU	PILXXLBCLYCAU	PILXXLBCLYROU	PILXXLBCLYZU
SYNTHETIC LEATHER STAMSKIN® WITHOUT BUTTONS	NOK 9.000	PILXXLBCLVCWU	PILXXLBCLVCCE	-	PILXXLBCLVCZU
SYNTHETIC LEATHER STAMSKIN® WITH BUTTONS	NOK 9.950	PILXXLBCLCWU	PILXXLBCLCCE	-	PILXXLBCLCZU

XXL CUSHION BANCA LOUNGE

M³ 0,23 m³ K^G 8,2 kgs

PIECERA 78 LOUNGE CUSHION

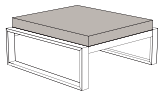

VERSION:	COLOUR:	WHITE	CAPPUCHINO / CENDRE	GREY	BLACK
STANDARD TEMPOTEST® FABRIC	NOK 2.400	PILPCL78WU	PILPCL78CAU	PILPCL78ROU	PILPCL78ZU
COZY TEMPOTEST® FABRIC	NOK 2.600	PILPCL78YWU	PILPCL78YCAU	PILPCL78YROU	PILPCL78YZU
SYNTHETIC LEATHER STAMSKIN® WITHOUT BUTTONS	NOK 3.400	PILPCL78VCWU	PILPCL78VCCE	-	PILPCL78VCZU
SYNTHETIC LEATHER STAMSKIN® WITH BUTTONS	NOK 3.600	PILPCL78CWU	PILPCL78CCE	-	PILPCL78CZU

CUSHION PIECERA 78 LOUNGE

M³ 0,06 m³ K^G 3,2 kgs

CUSHIONS: MATERIAL & COLOURS

TEMPOTEST®
100% SOLUTION DYED ACRYLIC FABRIC



WHITE
(WU)

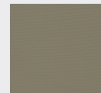

CAPPUCHINO
(CAU)



GREY
(ROU)



BLACK
(ZU)

STAMSKIN®
ALL WEATHER SYNTHETIC LEATHER WITHOUT BUTTONS

STAMSKIN®
TOP



WHITE
(VCWU)



CENDRE
(VCCE)



BLACK
(VCZU)

STAMSKIN®
ALL WEATHER SYNTHETIC LEATHER WITH BUTTONS

STAMSKIN®
TOP



WHITE
(CWU)



CENDRE
(CCE)



BLACK
(CZU)

PRODUCT

PRICES & REFERENCES

SPECS

PIECERA 130 LOUNGE CUSHION



VERSION:	COLOUR:	WHITE	CAPPUCHINO / CENDRE	GREY	BLACK
STANDARD TEMPOTEST® FABRIC	NOK 3.500	PILPCL130WU	PILPCL130CAU	PILPCL130ROU	PILPCL130ZU
COZY TEMPOTEST® FABRIC	NOK 4.300	PILPCL130YWU	PILPCL130YCAU	PILPCL130YROU	PILPCL130YZU
SYNTHETIC LEATHER STAMSKIN® WITHOUT BUTTONS	NOK 5.200	PILPCL130VCWU	PILPCL130VCCE	-	PILPCL130VCZU
SYNTHETIC LEATHER STAMSKIN® WITH BUTTONS	NOK 5.800	PILPCL130CWU	PILPCL130CCE	-	PILPCL130CZU

CUSHION PIECERA 130 LOUNGE

M³ 0,10 m³ K^G 5,0 kgs

SIESTA LOUNGE CUSHION

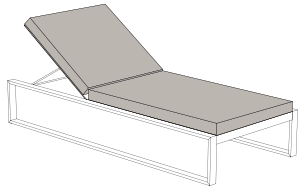

VERSION:	COLOUR:	WHITE	CAPPUCHINO / CENDRE	GREY	BLACK
STANDARD TEMPOTEST® FABRIC	NOK 6.300	PILSTLWU	PILSTLCAU	PILSTLROU	PILSTLZU
COZY TEMPOTEST® FABRIC	NOK 7.500	PILSTLYWU	PILSTLYCAU	PILSTLYROU	PILSTLYZU
SYNTHETIC LEATHER STAMSKIN® WITHOUT BUTTONS	NOK 8.200	PILSTLVCWU	PILSTLVCCE	-	PILSTLVCZU
SYNTHETIC LEATHER STAMSKIN® WITH BUTTONS	NOK 8.800	PILSTLCWU	PILSTLCCE	-	PILSTLCZU

CUSHION SIESTA LOUNGE

M³ 0,20 m³ K^G 9,4 kgs

* SIESTA LOUNGE TWIN REQUIRES TWO CUSHIONS

SIESTA LOUNGE HEAD CUSHION

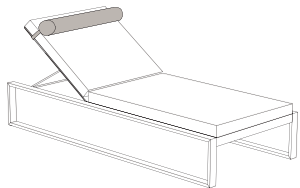

VERSION:	COLOUR:	WHITE	CAPPUCHINO / CENDRE	GREY	BLACK
STANDARD TEMPOTEST® FABRIC	NOK 1.400	PILRLLWU	PILRLLCAU	PILRLLROU	PILRLLZU
SYNTHETIC LEATHER STAMSKIN® WITHOUT BUTTONS	NOK 1.600	PILRLLVCWU	PILRLLVCCE	-	PILRLLVCZU

HEAD CUSHION SIESTA LOUNGE

M³ 0,01 m³ K^G 2,9 kgs

CUSHIONS: MATERIAL & COLOURS

TEMPOTEST®

100% SOLUTION DYED ACRYLIC FABRIC



WHITE
(WU)



CAPPUCHINO
(CAU)



GREY
(ROU)



BLACK
(ZU)

STAMSKIN®

ALL WEATHER SYNTHETIC LEATHER WITHOUT BUTTONS

STAMSKIN®
TOP



WHITE
(VCWU)



CENDRE
(VCCE)



BLACK
(VCZU)

STAMSKIN®

ALL WEATHER SYNTHETIC LEATHER WITH BUTTONS

STAMSKIN®
TOP



WHITE
(CWU)



CENDRE
(CCE)



BLACK
(CZU)

MODULAR SYSTEM

EXAMPLES OF ARRANGEMENTS OF MODULAR LOUNGE SETS

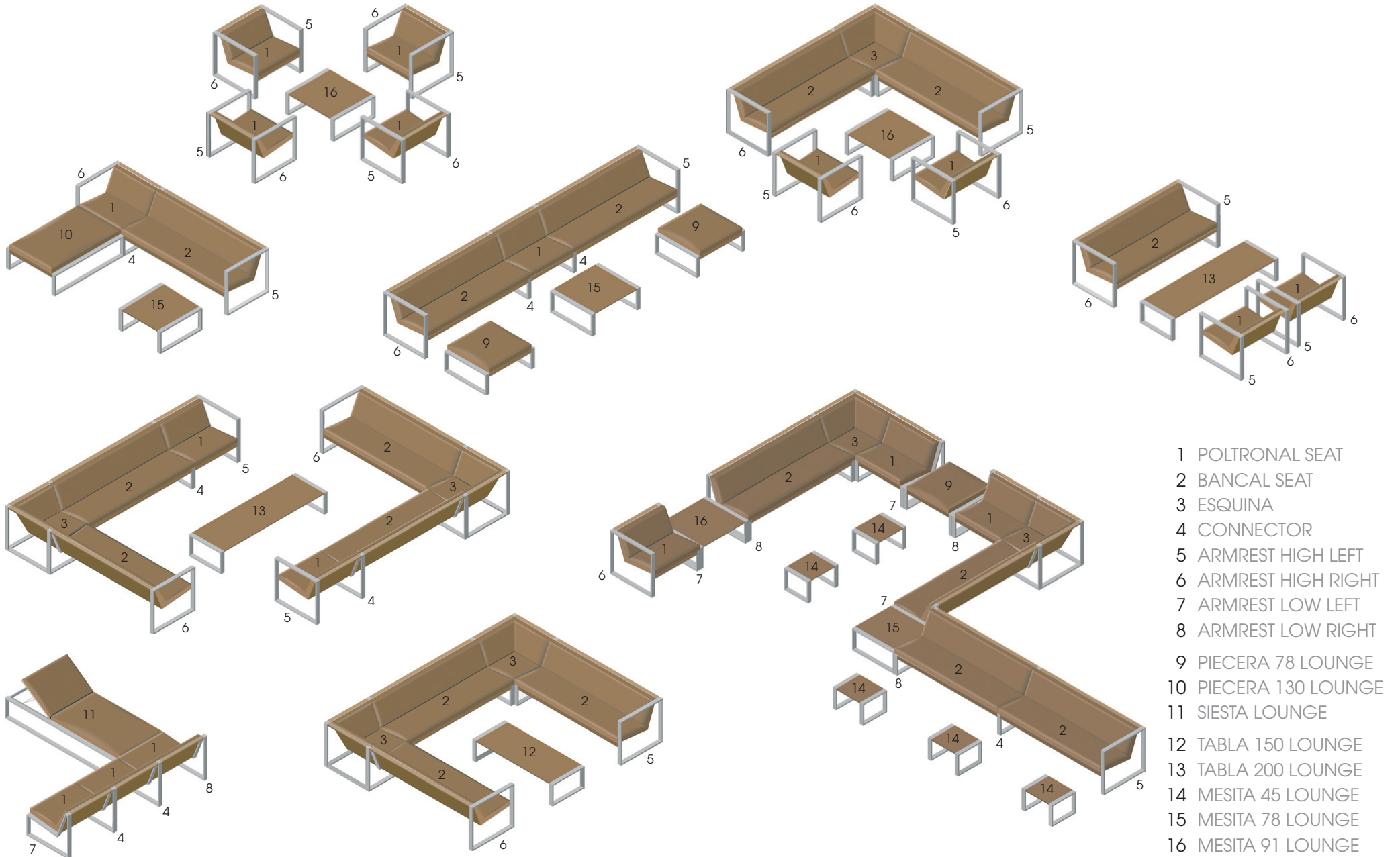

- 1 POLTRONA SEAT
- 2 BANCAL SEAT
- 3 ESQUINA
- 4 CONNECTOR
- 5 ARMREST HIGH LEFT
- 6 ARMREST HIGH RIGHT
- 7 ARMREST LOW LEFT
- 8 ARMREST LOW RIGHT
- 9 PIECERA 78 LOUNGE
- 10 PIECERA 130 LOUNGE
- 11 SIESTA LOUNGE
- 12 TABLA 150 LOUNGE
- 13 TABLA 200 LOUNGE
- 14 MESITA 45 LOUNGE
- 15 MESITA 78 LOUNGE
- 16 MESITA 91 LOUNGE

SHELL COLLECTION

PRODUCT

PRICES & REFERENCES

SPECS

SHELL CHAIR CHAIR



FRAME:	BRUSHED STAINLESS STEEL	ELECTRO POLISHED STAINLESS STEEL	POWDERCOATED STAINLESS STEEL WHITE	POWDERCOATED STAINLESS STEEL CENDRE	POWDERCOATED STAINLESS STEEL BLACK
SEAT:					
BATYLINE® FIBRE WHITE	-	NOK 5.950 SCREPWU	-	-	-
CENDRE	-	NOK 5.950 SCREPCE	-	-	-
BLACK	-	NOK 5.950 SCREPZU	-	-	-
CUSHION	STANDARD TEMPOTEST® FABRIC NOK 890 FOR MORE INFORMATION ABOUT CUSHIONS SEE PAGE 32				

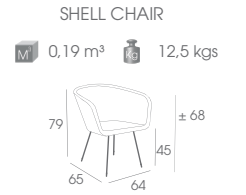

SHELL EASY CHAIR EASY CHAIR

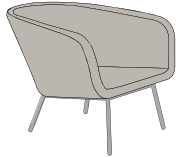

FRAME:	BRUSHED STAINLESS STEEL	ELECTRO POLISHED STAINLESS STEEL	POWDERCOATED STAINLESS STEEL WHITE	POWDERCOATED STAINLESS STEEL CENDRE	POWDERCOATED STAINLESS STEEL BLACK
SEAT:					
BATYLINE® FIBRE WHITE	-	NOK 8.900 SECEPWU	-	-	-
CENDRE	-	NOK 8.900 SECEPCE	-	-	-
BLACK	-	NOK 8.900 SECEPZU	-	-	-
CUSHION	STANDARD TEMPOTEST® FABRIC NOK 990 FOR MORE INFORMATION ABOUT CUSHIONS SEE PAGE 32				



SHELL SOFA SOFA

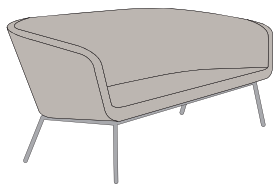

FRAME:	BRUSHED STAINLESS STEEL	ELECTRO POLISHED STAINLESS STEEL	POWDERCOATED STAINLESS STEEL WHITE	POWDERCOATED STAINLESS STEEL CENDRE	POWDERCOATED STAINLESS STEEL BLACK
SEAT:					
BATYLINE® FIBRE WHITE	-	NOK 15.900 SSFEPWU	-	-	-
CENDRE	-	NOK 15.900 SSFEPCE	-	-	-
BLACK	-	NOK 15.900 SSFEPZU	-	-	-
CUSHION	STANDARD TEMPOTEST® FABRIC NOK 1.950 FOR MORE INFORMATION ABOUT CUSHIONS SEE PAGE 32				

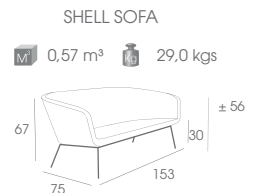







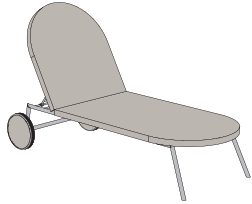

PRODUCT

PRICES & REFERENCES

SPECS

SHELL SUNBED
SUNBED



FRAME:		BRUSHED STAINLESS STEEL	ELECTRO POLISHED STAINLESS STEEL	POWDERCOATED STAINLESS STEEL WHITE	POWDERCOATED STAINLESS STEEL CENDRE	POWDERCOATED STAINLESS STEEL BLACK
						
SEAT:						
BATYLINE® FIBRE WHITE		-	NOK 15.900 SSBEPWU	-	-	-
CENDRE		-	NOK 15.900 SSBEPCE	-	-	-
BLACK		-	NOK 15.900 SSBEPZU	-	-	-
CUSHION	STANDARD TEMPOTEST® FABRIC NOK 3.950 FOR MORE INFORMATION ABOUT CUSHIONS SEE PAGE 32					

SHELL SUNBED

 0,61 m³  31,3 kgs

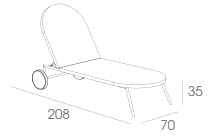

PRODUCT

PRICES & REFERENCES

SPECS

SHELL DINING 100
TABLE



TOP: GLASS 10 mm		BASE:				
		BRUSHED STAINLESS STEEL	ELECTRO POLISHED STAINLESS STEEL	POWDERCOATED STAINLESS STEEL WHITE	POWDERCOATED STAINLESS STEEL CENDRE	POWDERCOATED STAINLESS STEEL BLACK
WHITE		-	NOK 11.950 SDN100GEPWU	-	-	-
CENDRE		-	NOK 11.950 SDN100GEPCLU	-	-	-
BLACK		-	NOK 11.950 SDN100GEPZU	-	-	-

SHELL DINING 100

0,37 m³ 39,6 kgs

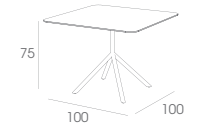

SHELL DINING 120
TABLE



TOP: GLASS 10 mm		BASE:				
		BRUSHED STAINLESS STEEL	ELECTRO POLISHED STAINLESS STEEL	POWDERCOATED STAINLESS STEEL WHITE	POWDERCOATED STAINLESS STEEL CENDRE	POWDERCOATED STAINLESS STEEL BLACK
WHITE		-	NOK 13.950 SDN120GEPWU	-	-	-
CENDRE		-	NOK 13.950 SDN120GEPCLU	-	-	-
BLACK		-	NOK 13.950 SDN120GEPZU	-	-	-

SHELL DINING 120

0,39 m³ 39,9 kgs



SHELL DINING 200
TABLE

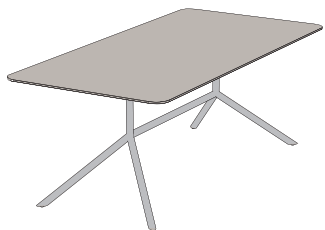

TOP: GLASS 10 mm		BASE:				
		BRUSHED STAINLESS STEEL	ELECTRO POLISHED STAINLESS STEEL	POWDERCOATED STAINLESS STEEL WHITE	POWDERCOATED STAINLESS STEEL CENDRE	POWDERCOATED STAINLESS STEEL BLACK
WHITE		-	NOK 24.950 SDN200GEPWU	-	-	-
CENDRE		-	NOK 24.950 SDN200GEPCLU	-	-	-
BLACK		-	NOK 24.950 SDN200GEPZU	-	-	-

SHELL DINING 200

1,22 m³ 87,9 kgs

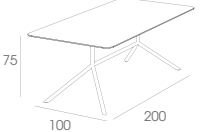

PRODUCT

PRICES & REFERENCES

SPECS

SHELL SALON
SALON TABLE



TOP: GLASS 10 mm	BASE:					
	BRUSHED STAINLESS STEEL	ELECTRO POLISHED STAINLESS STEEL	POWDERCOATED STAINLESS STEEL WHITE	POWDERCOATED STAINLESS STEEL CENDRE	POWDERCOATED STAINLESS STEEL BLACK	
WHITE	-	NOK 9.950 SSLGEPWU	-	-	-	
CENDRE	-	NOK 9.950 SSLGEPCLU	-	-	-	
BLACK	-	NOK 9.950 SSLGEPZU	-	-	-	

SHELL SALON
0,18 m³ 25,9 kgs



SHELL SIDE 40
SIDE TABLE



TOP: GLASS 10 mm	BASE:					
	BRUSHED STAINLESS STEEL	ELECTRO POLISHED STAINLESS STEEL	POWDERCOATED STAINLESS STEEL WHITE	POWDERCOATED STAINLESS STEEL CENDRE	POWDERCOATED STAINLESS STEEL BLACK	
WHITE	-	NOK 4.100 SSD40GEPWU	-	-	-	
CENDRE	-	NOK 4.100 SSD40GEPCLU	-	-	-	
BLACK	-	NOK 4.100 SSD40GEPZU	-	-	-	

SHELL SIDE 40
0,07 m³ 8,3 kgs

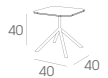

SHELL SIDE 50
SIDE TABLE



TOP: GLASS 10 mm	BASE:					
	BRUSHED STAINLESS STEEL	ELECTRO POLISHED STAINLESS STEEL	POWDERCOATED STAINLESS STEEL WHITE	POWDERCOATED STAINLESS STEEL CENDRE	POWDERCOATED STAINLESS STEEL BLACK	
WHITE	-	NOK 4.750 SSD50GEPWU	-	-	-	
CENDRE	-	NOK 4.750 SSD50GEPCLU	-	-	-	
BLACK	-	NOK 4.750 SSD50GEPZU	-	-	-	

SHELL SIDE 50
0,08 m³ 8,4 kgs



CUSHIONS SHELL COLLECTION & SCATTER CUSHIONS

PRODUCT PRICES & REFERENCES SPECS

SHELL CHAIR CUSHION



VERSION:	COLOUR:	WHITE	CAPPUCHINO	GREY	CHOCOLAT	BLACK	LIME GREEN
STANDARD TEMPOTEST® FABRIC	NOK 890	PILSCRWU	PILSCRC AU	PILSCRROU	PILSCRCHU	PILSCRZU	PILSCR LU

CUSHION SHELL CHAIR
 0,01 m³ 0,4 kgs

SHELL EASY CHAIR CUSHION



VERSION:	COLOUR:	WHITE	CAPPUCHINO	GREY	CHOCOLAT	BLACK	LIME GREEN
STANDARD TEMPOTEST® FABRIC	NOK 990	PILSECWU	PILSECC AU	PILSECROU	PILSECCHU	PILSECZU	PILSECLU

CUSHION SHELL EASY CHAIR
 0,02 m³ 0,6 kgs

SHELL SOFA CUSHION



VERSION:	COLOUR:	WHITE	CAPPUCHINO	GREY	CHOCOLAT	BLACK	LIME GREEN
STANDARD TEMPOTEST® FABRIC	NOK 1.950	PILSSFUWU	PILSSFCAU	PILSSFROU	PILSCRCHU	PILSSFZU	PILSSF LU

CUSHION SHELL SOFA
 0,05 m³ 1,8 kgs

SHELL SUNBED CUSHION



VERSION:	COLOUR:	WHITE	CAPPUCHINO	GREY	CHOCOLAT	BLACK	LIME GREEN
STANDARD TEMPOTEST® FABRIC	NOK 3.950	PILSSBWU	PILSSBC AU	PILSSBROU	PILSSBCHU	PILSSBZU	PILSSBLU

CUSHION SHELL SUNBED
 0,07 m³ 2,8 kgs

SCATTER CUSHION



VERSION:	COLOUR:	WHITE	CAPPUCHINO	GREY	CHOCOLAT	BLACK	LIME GREEN
STANDARD TEMPOTEST® FABRIC	NOK 590	PIL40RSWU	PIL40RSC AU	PIL40RSROU	PIL40RSCHU	PIL40RSZU	PIL40RSLU

SCATTER CUSHION PIL40
 0,01 m³ 0,4 kgs

CUSHIONS: MATERIAL & COLOURS
 TEMPOTEST®
 100% SOLUTION DYED ACRYLIC FABRIC

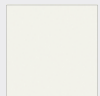

WHITE
(WU)



CAPPUCHINO
(CAU)



GREY
(ROU)



CHOCOLAT
(CHU)



BLACK
(ZU)



LIME GREEN
(LU)

E-VOLVED COLLECTION

PRODUCT PRICES & REFERENCES SPECS

E-VOLVED 140
TABLE

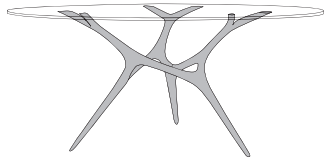

TOP: GLASS 10 mm TRANSPARENT	BASE:	HAND POLISHED STAINLESS STEEL	COATED ALUMINIUM WHITE	COATED ALUMINIUM CENDRE	COATED ALUMINIUM BLACK
		NOK 62.000 EVD140TR	NOK 62.000 EVD140WULTR	NOK 62.000 EVD140CAUTR	NOK 62.000 EVD140ZULTR

E-VOLVED 140
 M³ 1,11 m³ K^g 83,4 kgs

 75
 Ø140

E-VOLVED 150
TABLE

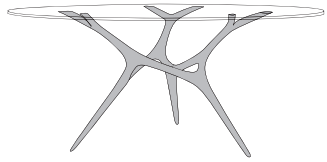

TOP: GLASS 10 mm TRANSPARENT	BASE:	HAND POLISHED STAINLESS STEEL	COATED ALUMINIUM WHITE	COATED ALUMINIUM CENDRE	COATED ALUMINIUM BLACK
		NOK 63.000 EVD150TR	NOK 63.000 EVD150WULTR	NOK 63.000 EVD150CAUTR	NOK 63.000 EVD150ZULTR

E-VOLVED 150
 M³ 1,14 m³ K^g 94,8 kgs

 75
 Ø150

E-VOLVED BASE ONLY
TABLE BASE

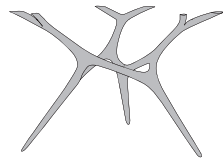

BASE ONLY	BASE:	HAND POLISHED STAINLESS STEEL	COATED ALUMINIUM WHITE	COATED ALUMINIUM CENDRE	COATED ALUMINIUM BLACK
		NOK 56.000 EVDBASE	NOK 56.000 EVDBASEWUL	NOK 56.000 EVDBASECAU	NOK 56.000 EVDBASEZUL

E-VOLVED BASE
 M³ 0,88 m³ K^g 58,3 kgs

 73
 105 105

ACCESSORIES & DECORATION

PRODUCT

MACETERO 50
PLANTER

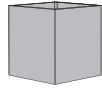

FRAME:	BRUSHED STAINLESS STEEL	ELECTRO POLISHED STAINLESS STEEL	POWDERCOATED STAINLESS STEEL WHITE	POWDERCOATED STAINLESS STEEL CENDRE	POWDERCOATED STAINLESS STEEL BLACK
MACETERO 50	NOK 7.450 MCT50	NOK 8.200 MCT50EP	NOK 8.200 MCT50WUL	NOK 8.200 MCT50CAU	NOK 8.200 MCT50ZUL

SPECS

MACETERO 50

0,13 m³ 24,4 kgs

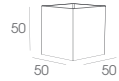

MACETERO 80
PLANTER

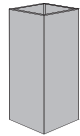

FRAME:	BRUSHED STAINLESS STEEL	ELECTRO POLISHED STAINLESS STEEL	POWDERCOATED STAINLESS STEEL WHITE	POWDERCOATED STAINLESS STEEL CENDRE	POWDERCOATED STAINLESS STEEL BLACK
MACETERO 80	NOK 8.900 MCT80	NOK 9.900 MCT80EP	NOK 9.900 MCT80WUL	NOK 9.900 MCT80CAU	NOK 9.900 MCT80ZUL

MACETERO 80

0,13 m³ 24,4 kgs

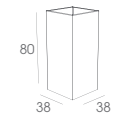

MACETERO 120
PLANTER

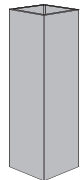

FRAME:	BRUSHED STAINLESS STEEL	ELECTRO POLISHED STAINLESS STEEL	POWDERCOATED STAINLESS STEEL WHITE	POWDERCOATED STAINLESS STEEL CENDRE	POWDERCOATED STAINLESS STEEL BLACK
MACETERO 120	NOK 11.900 MCT120	NOK 12.900 MCT120EP	NOK 12.900 MCT120WUL	NOK 12.900 MCT120CAU	NOK 12.900 MCT120ZUL

MACETERO 120

0,19 m³ 34,0 kgs

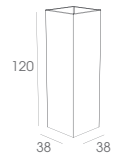

PRODUCT

SCATTER CUSHION



PRICES & REFERENCES

VERSION:	COLOUR:	WHITE	CAPPUCHINO	GREY	CHOCOLAT	BLACK	LIME GREEN
STANDARD TEMPOTEST® FABRIC	NOK 590	PIL40RSWU	PIL40RSCAU	PIL40RSROU	PIL40RSCHU	PIL40RSZU	PIL40RSLU

SCATTER CUSHION PIL40

0,01 m³ 0,4 kgs

FOR MORE INFORMATION ABOUT CUSHIONS SEE PAGE 32

ACCESSORIES & DECORATION

PRODUCT

PRICES & REFERENCES

SPECS

FURNITURE OUTDOOR COVERS
RAIN COVERS

SIZE:	TYPE	REFERENCE	PRICE
 75 93 80	COVER FOR POLTRONA LOUNGE	ODCPTL	NOK 3.500
75 200 80	COVER FOR BANCA LOUNGE	ODCBCL	NOK 3.900
75 290 80	COVER FOR POLTRONA+BANCA LOUNGE (MODULAR SYSTEM WITH CONNECTOR)	ODCBCLSP001	NOK 5.500
33 93 80	COVER FOR PIECERA 78 LOUNGE	ODCPCL78	NOK 2.200
33 93 132	COVER FOR PIECERA 130 LOUNGE	ODCPCL130	NOK 2.500
33 93 212	COVER FOR SIESTA LOUNGE	ODCSTL	NOK 3.600
35 152 62	COVER FOR TABLA 150 LOUNGE	ODCTLL150	NOK 2.300
35 200 62	COVER FOR TABLA 200 LOUNGE	ODCTLL200	NOK 2.500
35 80 80	COVER FOR MESITA 78 LOUNGE	ODCMSL78	NOK 2.000
35 93 80	COVER FOR MESITA 91 LOUNGE	ODCMSL91	NOK 2.200
75 152 152	COVER FOR TABLE & CHAIRS	ODCDNG150	NOK 4.000
75 185 135	COVER FOR TABLE & CHAIRS	ODCDNG180	NOK 4.600
OTHER SIZE COVERS ARE AVAILABLE ON REQUEST			

MATERIAL & COLOUR

 **STAMOID®**
Swiss made



STAMOID
TAUPE

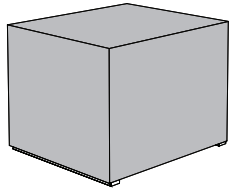

MATERIALS & FABRICS

STAINLESS STEEL

Stainless steel is commonly known as rust-free steel (RFS) or Inox. This is a ferrous alloy that increases the corrosion resistance of a substance by the addition of chrome and nickel. The principle is based on protecting the surface area by means of chrome-oxide and nickel-oxide molecules. These molecules are much larger than the underlying iron molecules, which prevents the latter from binding with oxygen and forming iron oxides – better known as rust.

In order to obtain a chrome-oxide and nickel-oxide surface that is of a high grade purity and homogeneity, thus achieving optimal corrosion resistance, the frames are etched and subjected to a passivating process as a standard treatment. Chlorine is RFS' greatest enemy and can cause a type of corrosion that is known as "pitting". For that reason, it is recommended that in locations near the seacoast - since sea salt is sodium chloride - the metal be given a surface made as smooth as possible in order to increase its resistance to corrosion even further. The smoother the surface, the less porous it is. The lower the porosity, the lower the possibility of dirt deposits accumulating on the metal surface, and thus the lower the risk of corrosion. For that reason, we recommend the optional electro-polishing treatment of the item's frame if it is to be used in a corrosive environment.

BATYLINE®

Batyline® is a woven polyester fibre protected by a PVC coating. The fibres are then bundled together in order to obtain an exceptionally solid fibrous substance that is permanent, resistant to stretching, and immune to cracking.

Batyline® does not deform or create pockets: Précontraint® Ferrari® technology, basis of a unique process, ensures the fabrics outstanding dimensional stability. The most important feature is its pliancy and optimal seating comfort. Batyline® textiles offer excellent resistance to mould and mildew and benefit from surface treatment against UV degradation. This surface treatment also offers exceptional resistance to dirt.

Batyline® fabrics are eco-designed, ensuring optimum usage of resources and favouring safety, environmental impact reduction and incorporation of renewable raw materials. Its production facilities (in France and Switzerland) are ISO 14 001 certified and use green electricity and renewable energy sources.

All Batyline® textiles are certified Oeko-Tex. This label guarantees the absence of undesirable substances for you and those close to you.



TEAK

Teak wood is produced by the Tectona Grandis, a tree that under favourable conditions can attain a height of up to 45 m, with a trunk diameter up to 2.4 meters. The wood's renowned durability is due to its high content of natural oils.

The limited absorption of moisture protects the wood from warping and thus gives the wood its enormous stability. In addition, the wood is highly resistant to attacks by pests. It is because of these qualities, as well as its exceptionally attractive hue and structure, that teak has deservedly received the title of "the noblest of all wood types".

In view of its high resistance, teakwood does not require additional protective measures. Nonetheless, a treatment to render the wood less sensitive to stains, or to keep the original colour of the wood, may be desired. Untreated wood, exposed to water and UV rays, will oxidise and take on a silver-grey sheen. It is simply a question of personal taste whether or not an individual wishes to allow the teak to "weather" to a silver-grey colour, or would rather maintain the original golden-brown colour of the wood.

GLASS

Its resistance to staining and scratching makes glass a highly suitable material for tabletops in outdoor furniture. The glass used in the FueraDentro collection is available in white, cendre (Café latte) and black versions. They have a matt acid-washed finish, which is very scratch- and fingerprint resistant. Only the E-Volved table is available with extra clear transparent glass.

Glass surfaces may be cleaned with classic glass cleaners.

In the case of stubborn dirt and calcium deposits, "Glass Heavy Duty Cleaner" may be used. Use only for serious contamination. Avoid contact with skin and eyes. Extra protection is required.

BELGIAN BLUESTONE

Belgian bluestone or "Little Granite" is a limestone with a more or less pronounced natural blue/grey colour, which is characterized by the presence of a large number of fossilized crinoids. This type of bluestone is only quarried in Belgium.

A beautiful limestone planking with a cool dark blue-gray colour palette with numerous inclusions. The inclusions are fossils of ancient sea life. Belgian Bluestone has humble origins and was used primarily as a ballast for ships and as road paving material. It became popular as an interior flooring material in the 19th century and can be found in luxury homes, exclusive hotels, and high-end retail stores throughout Europe. Precision cut with sawn sides and backs, it offers a consistently square piece. The colour consistency from piece to piece is good. It is a dense, durable material that is suitable for many applications.

- It develops a natural patina: use: outdoors, changes due to the action of rain and UV-rays to its original pale blue-grey colour use : indoors in the course of time, it develops a deeper colour
- Bluestone is susceptible to products and scratches
- Belgian bluestone can often contain a number of white veins, black lines, spots and fossils.
- Depending on the finishing, the stone has a different look "White veins" are water veins, formed by water, 100% specific to bluestone and are not cracks as people often assume. Fossils and colour differences: stone is a natural material formed by different perfectly petrified fossils. So it is normal to find nests of crustaceans in the stone. In other words, even in one sheet of stone clear differences in colour can be observed.

MATERIALS & FABRICS

TEMPOTEST®

Tempotest® is a fabric particularly suitable for outdoor use. Tempotest® is woven from mass-coloured acrylic fibre; your security for optimal water- and UV resistance, plus years of optimal comfort. General information and maintenance.

Most stains on the material can be cleaned with mild soap and water. Simply remove dirt by scrubbing with water (under 40°C) and natural soap. Rinse liberally with clean water to remove all the soap. Removable covers can be washed at 40°C in the washing machine. Do not iron or spin dry. To prevent creasing replace the covers while still damp, and dry in the open air. Store the material in a dry, well-ventilated area in winter.

STAMSKIN®



Stamskin® is a fabric particularly suitable for outdoor use. With its unique elasticity and suppleness, this artificial leather offers outstanding seating comfort. General information and maintenance.

Stamskin®, produced by Serge Ferrari, benefits from a manufacturing technique which gives it incomparable flexibility. Its elegant appearance and pleasant feel are particularly appreciated. Comfortable, easy to care for and weather resistant, Stamskin® is known for its undeniable advantages.

Its strength, durability and easy care make Stamskin® a fabric particularly suitable for outdoor use. With its unique elasticity and suppleness, this synthetic leather offers outstanding seating comfort. The nature of its base-cloth and the composition of Stamskin Top® offers longevity. This material has an excellent resistance to ultraviolet radiation (UV) and is treated to resist micro-organism and mould. Stamskin Top® is classified flame retardant in accordance with current European fire safety standard.

STAMOID®



Stamoid is a vinyl coated woven polyester, completely waterproof, easily cleanable, cool to sit under, and folds and stores well. The high tenacity weave holds its shape and does not show humidity sagging problems common to lower marine grade fabrics.

The vinyl sides are very easy to clean with a sponge and mild detergent.



PROJECT THE SQUAIRE - FRANKFURT, GERMANY

FUERADENTRO
PRINSENGRACHT 624 S
1017 KT AMSTERDAM
THE NETHERLANDS

T +31 20 6245111
F +31 20 4272646
E INFO@FUERADENTRO.COM

FUERADENTRO.COM

FUERADENTRO